

# Simulink<sup>®</sup> Report Generator<sup>™</sup>

## User's Guide

**R2012b**

**MATLAB<sup>®</sup>  
& SIMULINK<sup>®</sup>**

## How to Contact MathWorks



[www.mathworks.com](http://www.mathworks.com) Web  
[comp.soft-sys.matlab](mailto:comp.soft-sys.matlab) Newsgroup  
[www.mathworks.com/contact\\_TS.html](http://www.mathworks.com/contact_TS.html) Technical Support



[suggest@mathworks.com](mailto:suggest@mathworks.com) Product enhancement suggestions  
[bugs@mathworks.com](mailto:bugs@mathworks.com) Bug reports  
[doc@mathworks.com](mailto:doc@mathworks.com) Documentation error reports  
[service@mathworks.com](mailto:service@mathworks.com) Order status, license renewals, passcodes  
[info@mathworks.com](mailto:info@mathworks.com) Sales, pricing, and general information



508-647-7000 (Phone)



508-647-7001 (Fax)



The MathWorks, Inc.  
3 Apple Hill Drive  
Natick, MA 01760-2098

For contact information about worldwide offices, see the MathWorks Web site.

*Simulink® Report Generator™ User's Guide*

© COPYRIGHT 1999–2012 by The MathWorks, Inc.

The software described in this document is furnished under a license agreement. The software may be used or copied only under the terms of the license agreement. No part of this manual may be photocopied or reproduced in any form without prior written consent from The MathWorks, Inc.

FEDERAL ACQUISITION: This provision applies to all acquisitions of the Program and Documentation by, for, or through the federal government of the United States. By accepting delivery of the Program or Documentation, the government hereby agrees that this software or documentation qualifies as commercial computer software or commercial computer software documentation as such terms are used or defined in FAR 12.212, DFARS Part 227.72, and DFARS 252.227-7014. Accordingly, the terms and conditions of this Agreement and only those rights specified in this Agreement, shall pertain to and govern the use, modification, reproduction, release, performance, display, and disclosure of the Program and Documentation by the federal government (or other entity acquiring for or through the federal government) and shall supersede any conflicting contractual terms or conditions. If this License fails to meet the government's needs or is inconsistent in any respect with federal procurement law, the government agrees to return the Program and Documentation, unused, to The MathWorks, Inc.

### Trademarks

MATLAB and Simulink are registered trademarks of The MathWorks, Inc. See [www.mathworks.com/trademarks](http://www.mathworks.com/trademarks) for a list of additional trademarks. Other product or brand names may be trademarks or registered trademarks of their respective holders.

### Patents

MathWorks products are protected by one or more U.S. patents. Please see [www.mathworks.com/patents](http://www.mathworks.com/patents) for more information.

## Revision History

January 1999	First printing	New (Release 11)
December 2000	Second printing	Revised (Release 12)
June 2004	Third printing	Revised for Version 2.02 (Release 14)
August 2004	Online only	Revised for Version 2.1
October 2004	Online only	Revised for Version 2.1.1 (Release 14SP1)
December 2004	Online only	Revised for Version 2.2 (Release 14SP1+)
April 2005	Online only	Revised for Version 2.2.1 (Release 14SP2+)
September 2005	Online only	Revised for Version 2.3.1 (Release 14SP3)
March 2006	Online only	Revised for Version 3.0 (Release 2006a)
September 2006	Online only	Revised for Version 3.1 (Release 2006b)
March 2007	Fourth printing	Revised for Version 3.2 (Release 2007a)
September 2007	Fifth printing	Revised for Version 3.2.1 (Release 2007b) This publication was previously for MATLAB® and Simulink®. It is now for Simulink® only.
March 2008	Online only	Revised for Version 3.3 (Release 2008a)
October 2008	Online only	Revised for Version 3.4 (Release 2008b)
October 2008	Online only	Revised for Version 3.5 (Release 2008b+)
March 2009	Online only	Revised for Version 3.6 (Release 2009a)
September 2009	Online only	Revised for Version 3.7 (Release 2009b)
March 2010	Online only	Revised for Version 3.8 (Release 2010a)
September 2010	Online only	Revised for Version 3.9 (Release 2010b)
April 2011	Online only	Revised for Version 3.10 (Release 2011a)
September 2011	Online only	Revised for Version 3.11 (Release 2011b)
March 2012	Online only	Revised for Version 3.12 (Release 2012a)
September 2012	Online only	Revised for Version 3.13 (Release 2012b)



## User's Guide

---

## Getting Started

---

# 1

---

<b>Product Description</b> .....	1-2
Key Features .....	1-2
<b>System Design Documentation and Results</b>	
<b>Reporting</b> .....	1-3
Types of Reports .....	1-3
System Design Documentation .....	1-3
Results Reporting .....	1-4
<b>Interactive Model Exploration</b> .....	1-6
Simulink Report Generator Tools .....	1-6
Simulink Model Exploration Tools .....	1-7
<b>Report Creation Workflow</b> .....	1-9
<b>Report Components</b> .....	1-10
About Report Components .....	1-10
Report Structure Components .....	1-11
System-Based Components .....	1-11
User-Supplied Information Components .....	1-13
Dynamic Reporting Components .....	1-14
Format Control at the Component Level .....	1-14
<b>Report Explorer</b> .....	1-15
About the Report Explorer .....	1-15

<b>How Simulink Report Generator and Simulink Software Interact</b> .....	<b>1-18</b>
<b>Supported Report Formats</b> .....	<b>1-20</b>
<b>Browser Requirements for Web Views</b> .....	<b>1-21</b>

## Examples

<b>Creating Reports</b> .....	<b>2</b>
<b>Generating Reports from MATLAB Files</b> .....	<b>3</b>
<b>Creating Web Views</b> .....	<b>4</b>
<b>Working with Components</b> .....	<b>5</b>

## Generate System Design Description Reports

# 2

<b>System Design Description</b> .....	<b>2-2</b>
Predefined Standard Reports .....	<b>2-2</b>
What Is the System Design Description? .....	<b>2-3</b>
What You Can Do with the Report .....	<b>2-3</b>
Report Contents .....	<b>2-3</b>
<b>Generate a System Design Description</b> .....	<b>2-7</b>
Open the System Design Description Dialog Box .....	<b>2-7</b>
Choose System Design Description Options .....	<b>2-7</b>
<b>Customize the System Design Description</b> .....	<b>2-10</b>
Using the Report Explorer to Customize the Report .....	<b>2-10</b>
Building a Dialog Box for a Custom Report Setup File ...	<b>2-11</b>

### 3

<b>Create a Simulink Report Generator Report</b> .....	<b>3-2</b>
<b>Report Options</b> .....	<b>3-3</b>
<b>Add Components to the Report Setup File</b> .....	<b>3-5</b>
Report Components .....	3-5
Add MATLAB Code .....	3-7
Add a Title Page .....	3-13
Open the Simulink Model .....	3-15
Add Logical Then and Logical Else Components .....	3-18
Error If Model Cannot Be Opened .....	3-19
Create the Body of the Report .....	3-22
Process with a Model Loop Component .....	3-23
Add a Paragraph for Each Model .....	3-25
Insert a Snapshot of the Model .....	3-27
Add a Loop for Processing the Model .....	3-28
Block Parameter Value from a MATLAB Expression .....	3-30
Create a Section for Each Iteration .....	3-32
Insert the Block Value .....	3-33
Set a Parameter Value .....	3-34
Check Value Using a Logical If Component .....	3-36
Simulate the Model Using a Model Simulation Component .....	3-39
Create a Post-Test Analysis Section .....	3-45
<b>Error Handling for MATLAB Code</b> .....	<b>3-53</b>
<b>Generate the Report</b> .....	<b>3-55</b>

## Generate a Report

### 4

<b>Generate a Report</b> .....	<b>4-2</b>
Run a Report .....	4-2
Report Output Options .....	4-2

<b>Set Report Output Options</b> .....	4-4
Report Output Format and Stylesheet .....	4-4
PDF Stylesheets .....	4-7
Web Stylesheets .....	4-8
RTF (DSSSL Print) and Word Stylesheets .....	4-9
Report Generation Processing .....	4-9
Output File Location .....	4-12
Regenerate Images .....	4-13
Add Description of Report Setup .....	4-14
<b>Change Report Locale</b> .....	4-15
<b>Convert XML Documents</b> .....	4-16
Why Convert XML Documents? .....	4-16
Convert XML Documents Using the Report Explorer .....	4-16
Convert XML Documents Using the Command Line .....	4-18
Edit XML Source Files .....	4-18
<b>Create a Log File</b> .....	4-19
<b>Generate MATLAB Code from Report Setup File</b> .....	4-20
<b>Legacy Report Setup Files</b> .....	4-23
What Are Legacy Report Setup Files? .....	4-23
Enable Legacy Interface .....	4-23
Use Legacy Interface .....	4-24
<b>Troubleshooting Report Generation Issues</b> .....	4-25
Memory Usage .....	4-25
HTML Report Display on UNIX Systems .....	4-25

## Export Simulink Models to Web Views

# 5

<b>Web Views</b> .....	5-2
<b>Export Models to the Web</b> .....	5-3



Open the Export Interface .....	5-3
Set Export Options .....	5-3
Generate and Review Web Views .....	5-5
<b>Navigate Web Views .....</b>	<b>5-7</b>
Display Web Views .....	5-7
View the Current Layer .....	5-7
View Layers Below the Top Layer .....	5-8
View All Layers .....	5-9
<b>Create Web Views of Simulink Models .....</b>	<b>5-11</b>
About This Tutorial .....	5-11
Specify Web View Export Options .....	5-11
Export Models .....	5-13
Navigate Web Views .....	5-14
<b>Troubleshooting Web Views .....</b>	<b>5-21</b>
Web View Display Issues .....	5-21

## Add Content with Components

# 6

<b>Components .....</b>	<b>6-2</b>
Control Format with Stylesheets .....	6-3
Control Format at the Component Level .....	6-3
<b>Report Structure Components .....</b>	<b>6-4</b>
<b>Table Formatting Components .....</b>	<b>6-5</b>
<b>Property Table Components .....</b>	<b>6-6</b>
About Property Table Components .....	6-6
Open the Example Report Template .....	6-8
Examine the Property Table Output .....	6-8
Select Object Types .....	6-9
Display Property Name/Property Value Pairs .....	6-9
Edit Table Titles .....	6-12
Enter Text into Table Cells .....	6-12

Add, Replace, and Delete Properties in Tables .....	6-13
Format Table Columns, Rows, and Cells .....	6-14
Zoom and Scroll .....	6-16
Select a Table .....	6-16
<b>Summary Table Components .....</b>	<b>6-17</b>
About Summary Table Components .....	6-17
Open the Example Report Template .....	6-19
Select Object Types .....	6-19
Add and Remove Properties .....	6-19
Set Relative Column Widths .....	6-20
Set Object Row Options .....	6-20
<b>Dynamic Reporting Components .....</b>	<b>6-22</b>
Logical and Looping Components .....	6-22
Edit Figure Loop Components .....	6-22

## Compare Simulink Model XML Files

# 7

<b>Compare Simulink Model XML Files .....</b>	<b>7-2</b>
Introduction .....	7-2
Overview of XML Comparison .....	7-3
Select Files to Compare .....	7-5
Choose a Comparison Type .....	7-7
Compare XML Files from Models with Identical Names ..	7-7
Examples of XML Comparison .....	7-8
<b>Explore the XML Comparison Report for Simulink</b>	
<b>Models .....</b>	<b>7-10</b>
Navigate the Simulink XML Comparison Report .....	7-10
Display Items in Original Models .....	7-14
Filter Out Differences .....	7-17
Merge Simulink Models From the Comparison Report ...	7-18
Understand the Report .....	7-20
Work with Referenced Models and Library Links .....	7-22
<b>Export, Print, and Save XML Comparison Results .....</b>	<b>7-24</b>
Export Printable Report .....	7-24

Export Results to the Workspace .....	7-24
Save Comparison Log Files in a Zip File .....	7-26

**Compare XML from Models Managed with**

<b>Subversion</b> .....	7-27
Work with Subversion .....	7-27
Create file_comparison_driver Function .....	7-28
Configure TortoiseSVN .....	7-28
Test TortoiseSVN Setup .....	7-30
Example file_comparison_driver Code .....	7-31

## Component Reference

# 8

---

<b>Simulink Coder Components</b> .....	8-2
<b>Requirements Management Interface Components</b> ...	8-3
<b>Simulink Components</b> .....	8-4
<b>Simulink Blocks Components</b> .....	8-7
<b>Simulink Fixed Point Components</b> .....	8-8
<b>Stateflow Components</b> .....	8-9

## Components — Alphabetical List

---

**9**

### Function Reference

---

**10**

GUI .....	10-2
Report Generation .....	10-3
Web Views .....	10-4

## Functions – Alphabetical List

---

**11**

### Examples

---

**A**

Creating Reports .....	A-2
Generating Reports from MATLAB Files .....	A-3
Creating Web Views .....	A-4
Working with Components .....	A-5

### Index

---

# User's Guide

---

Chapter 1, Getting Started (p. 1-1)	Overview of Simulink® Report Generator™ product
Chapter 2, Generate System Design Description Reports (p. 2-1)	How to create a System Design Description report for a Simulink model
Chapter 3, Creating Simulink Reports (p. 3-1)	A step-by-step example that creates a Simulink report
Chapter 4, Generate a Report (p. 4-1)	How to format and generate reports
Chapter 5, Export Simulink Models to Web Views (p. 5-1)	How to create interactive renditions of Simulink models that you can view in Web browsers
Chapter 6, Add Content with Components (p. 6-1)	Examples of building report setup files with various components
Chapter 7, Compare Simulink Model XML Files (p. 7-1)	Introduces XML comparison
Appendix A, Examples (p. A-1)	



# Getting Started

---

- “Product Description” on page 1-2
- “System Design Documentation and Results Reporting” on page 1-3
- “Interactive Model Exploration” on page 1-6
- “Report Creation Workflow” on page 1-9
- “Report Components” on page 1-10
- “Report Explorer” on page 1-15
- “How Simulink® Report Generator™ and Simulink Software Interact” on page 1-18
- “Supported Report Formats” on page 1-20
- “Browser Requirements for Web Views” on page 1-21

## Product Description

### **Generate documentation for Simulink and Stateflow® models**

The Simulink Report Generator product can automatically create documentation from Simulink and Stateflow models. It lets you document software requirements and design specifications and produce reports from your models, all in a standard format.

### **Key Features**

- Lets you create interactive renditions of your Simulink and Stateflow models that can be viewed in a web browser
- Enables push-button documentation of Simulink and Stateflow models and simulation results
- Simulates models and executes MATLAB® commands within reports
- Enables conditional documentation generation via logical template components, such as IF, THEN, ELSE, and WHILE
- Lets you create and distribute documentation templates using customized style sheets
- Provides extensible components and style sheets
- Creates reports in multiple formats, including HTML, PDF, RTF, Microsoft® Word, and XML



# System Design Documentation and Results Reporting

In this section...
“Types of Reports” on page 1-3
“System Design Documentation” on page 1-3
“Results Reporting” on page 1-4

## Types of Reports

Two common user goals for reports are:

- System design documentation — Capture information about the design decisions, structure, implementation, and operational details of a system.
- Results reporting — Present results of running a system.

You use a very similar workflow for creating and generating both kinds of reports. However, some components are particularly useful for one or the other kind of report.

## System Design Documentation

System documentation has many uses, including:

- Capturing design decisions
- Recording implementation details
- Communicating the system design and interfaces among groups

You can view information about a system without creating a report. For more information, see “Interactive Model Exploration” on page 1-6.

When you create a Simulink Report Generator report to provide system design documentation, the report captures information about the system design directly from the model. Each time that you generate the report, you see up-to-date documentation for the design.

The following table includes some examples of components that are useful for system design documentation reports.

<b>System Information</b>	<b>Examples of Components to Use</b>
Requirements	Requirements Summary Table (for requirements specified with Simulink Verification and Validation™)
System layout	System Hierarchy, System Snapshot
Model configuration	Model Configuration Set, Model Advisor Report
Block parameter settings	Simulink Dialog Snapshot, Block Loop
Properties	Simulink Property Table, Simulink Summary Table
Variables	Variable Table, Simulink Workspace Variable
System documentation included in a model	Documentation, Simulink Name

## **Results Reporting**

Results reporting has many uses, including:

- Model regression testing
- Verifying and validating designs
- Exploring design alternatives
- Optimizing designs

Simulink provides several tools for examining the results of a simulation. Simulation data includes signal, time, output, state, and data store logging data. You can set up your model to export simulation data to the MATLAB workspace during simulation for later retrieval, analysis, and postprocessing. You can use several approaches to explore the simulation data. For details, see “Export Simulation Data” in the Simulink documentation.

You can report on results without creating a report. For more information, see “Interactive Model Exploration” on page 1-6.

The following table includes some examples of components that are useful results reports.

<b>Results Information</b>	<b>Examples of Components to Use</b>
Signal values	Scope Snapshot, Block Loop
Simulation processing	Model Simulation, Model Configuration Set, Fixed-Point Logging Options
Figures generated with MATLAB	Figure Snapshot, To Workspace Plot
Generated code	Code Generation Summary, Import Generated Code

You can use components such as the Model Simulation component to control how the model simulates. Other components, such as the Scope Snapshot, show the results of the simulation.

## Interactive Model Exploration

In this section...
“Simulink® Report Generator™ Tools” on page 1-6
“Simulink Model Exploration Tools” on page 1-7

### Simulink Report Generator Tools

The Simulink Report Generator provides tools that you can use to obtain information about models, without creating report setup files:

- Predefined standard reports
- Web View
- XML Comparison report

### Predefined Standard Reports

From the Simulink Model Editor, you can access two predefined, standard Simulink Report Generator reports:

- System Design Description
- Design Requirements (requires Simulink Verification and Validation)

The System Design Description report provides summary or detailed information about a system design represented by a model. You can choose report options with the report dialog box, or you can create a customized version using the Report Explorer. For details, see “Generate a System Design Description” on page 2-7.

You can use the System Design Description report setup file as a starting point for creating a setup file for your own report.

You can also generate an HTML model report for Stateflow charts.

You must have the Simulink Verification and Validation product installed to use the Design Requirements report. The Design Requirements report includes information about all the requirements associated with the model

and its objects. For details, see “Creating and Customizing a Requirements Report” in the Simulink Verification and Validation documentation.

## Web View

A Web view is an interactive rendition of a model that you can view in a Web browser. You can use Web views to navigate hierarchically to specific subsystems and see properties of blocks, signals, and scopes. You can zoom in and out, pan, and fit your model to your view using the same keyboard shortcuts that you use in Simulink and Stateflow editors.

Web views are useful for presenting models to audiences and for sharing models with colleagues who do not have MathWorks® products installed.

For details, see “Export Models to the Web” on page 5-3.

## XML Comparison Report

You can use Simulink Report Generator software to compare XML text renditions of different versions of a Simulink model and to compare the XML renditions to explore differences between versions of the model. You can also compare the XML text renditions of two different models.

For details, see “Model Comparison”.

## Simulink Model Exploration Tools

You can generate a model report, which is an HTML document that describes the structure and content of a model. The model report includes block diagrams of the model and its subsystems and the settings of its block parameters. To generate the report, from the Simulink Model Editor, select **File > Print Details**. For more information, see “Generate a Model Report”.

To interactively focus on specific elements of a model (for example, blocks, signals, and properties) without navigating through the model diagram or chart, using the Model Explorer. To open the Model Explorer, in the Simulink Model Editor, select **View > Model Explorer**. For details, see “Model Explorer Overview”.

To generate a report that lists the suboptimal conditions or settings in a model, with suggestions for better model configuration settings where appropriate, use the Model Advisor. To open the Model Advisor, in the Simulink Model Editor, select **Analysis > Model Advisor**. For details, see “Consult the Model Advisor”

To navigate a model hierarchically, open systems in a model, and determine the blocks contained in a model, you can use the Simulink Model Browser. To open the Model Browser, select **View > Model Browser Options > Model Browser**. For details, see “Model Browser”.

Simulink provides several tools for examining the results of a simulation. Simulation data includes signal, time, output, state, and data store logging data. You can set up your model to export simulation data to the MATLAB workspace during simulation for later retrieval, analysis, and postprocessing. You can use several approaches to explore the simulation data. For example, you can use the Simulation Data Inspector to generate a report with plots of simulation data. For details, see “Export Runtime Information” in the Simulink documentation.

## Report Creation Workflow

- 1** Open the Report Explorer. In the menu bar on the Simulink model window, click **Tools > Report Generator**.
- 2** Create a new report setup file. For more information about report setup files, see “Report Setup”.
- 3** Add existing Simulink or Stateflow components to the report setup file, or create your own custom components. For more information on using components, see “Add Components”.
- 4** Choose an existing stylesheet or create a custom stylesheet to apply styles and standards to the report setup file. For more information, see “Layout Stylesheets”.
- 5** Generate the report.

The following figure illustrates a typical Simulink Report Generator workflow.

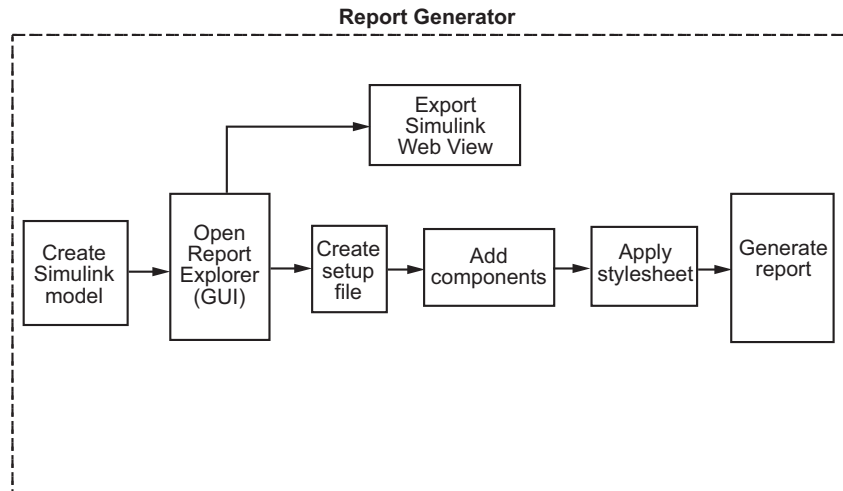

## Report Components

In this section...
“About Report Components” on page 1-10
“Report Structure Components” on page 1-11
“System-Based Components” on page 1-11
“User-Supplied Information Components” on page 1-13
“Dynamic Reporting Components” on page 1-14
“Format Control at the Component Level” on page 1-14

### About Report Components

Components are modules that you include in a report setup file to insert elements, such as tables, lists, and figures, into a report. You also can use components to control report generation processing.

Many components have parent-child relationships with other components. For example, a child components of a Paragraph component include components such as Text, Image, and Insert Variable.

Use a combination of the following types of components in your report setup file.

Component Type	Description
“Report Structure Components” on page 1-11	Include a title page, sections, and other components to organize the content of a report.
“System-Based Components” on page 1-11	Include components that automatically obtain information directly from a model to include in a report.



Component Type	Description
“User-Supplied Information Components” on page 1-13	Include text and graphics that you supply, independent of a model.
“Dynamic Reporting Components” on page 1-14	Set up dynamic control for when to include components and what information to report on for a component, based on data from a model or on other conditions that you specify.

Use the Report Explorer to add components to a report and to specify component properties.

## Report Structure Components

To add a title page, use a `Title Page` component. You can include an abstract and legal notice information. For an example, see “Add a Title Page” on page 3-13.

To organize a report into sections, use `Chapter/Subsection` components. For an example, see “Create a Section for Each Iteration” on page 3-32.

## System-Based Components

The Simulink Report Generator includes many components that obtain information directly from a model and include that information in a report. Using system-based components allows your report to reflect the current state of a model. You can generate the report whenever you want to capture the latest version of a model, without changing the report setup file.

Property table components display property name/property value pairs for objects in tables. Summary table components insert tables that include specified properties for objects into generated reports. The tables contain one object per row, with each object property appearing in a column, as shown in the following summary table.

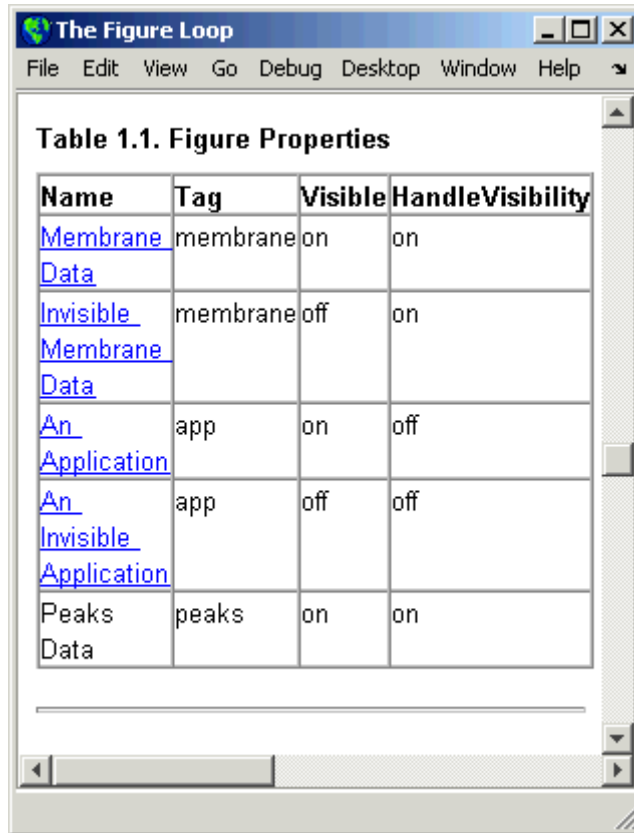

The screenshot shows a window titled "The Figure Loop" with a menu bar (File, Edit, View, Go, Debug, Desktop, Window, Help). The main content area displays a table titled "Table 1.1. Figure Properties". The table has four columns: Name, Tag, Visible, and HandleVisibility. The rows represent different figure components with their respective tags and visibility settings.

Name	Tag	Visible	HandleVisibility
<a href="#">Membrane Data</a>	membrane	on	on
<a href="#">Invisible Membrane Data</a>	membrane	off	on
<a href="#">An Application</a>	app	on	off
<a href="#">An Invisible Application</a>	app	off	off
Peaks Data	peaks	on	on

To use descriptive information from DocBlock blocks, use the Documentation component.

A few examples of system-based components include:

- MATLAB Property Table
- Simulink Workspace Variable
- System Hierarchy
- Simulink Summary Table
- Simulink Dialog Snapshot

- Block Execution Order List
- Model Loop
- Model Configuration Set
- Scope Snapshot

For examples of using system-based components, see:

- “Property Table Components” on page 6-6
- “Summary Table Components” on page 6-17
- “Create the Body of the Report” on page 3-22

The Simulink Report Generator also includes system-based components that contain model elements from the following Simulink products:

- Stateflow
- Simulink Fixed Point™
- Simulink Coder™
- Simulink Verification and Validation

## **User-Supplied Information Components**

In addition to using system-based components to extract data from a system and insert that information into a report, you can also add content that you, or others, supply. For example, to include text, use the Paragraph and Text components.

To insert a graphic from a file, use an Image component. To insert ASCII text, use an Import File component.

To include notes about the report source files, use a Comment component.

For an example, see “Add Introductory Text to the First Chapter”.

## **Dynamic Reporting Components**

Dynamic reporting components execute conditionally, enabling you to decide when a child component executes or how many times a child component executes. To control the report generation flow, use logical and flow components such as `Logical If`, `Logical Then`, `While Loop`, or `For Loop`.

A looping component runs its child components a specified number of times. There are several looping components, including logical loops, Handle Graphics® loops, and model and chart loops. For model and chart loops, you can control aspects such as the order in which the report sorts blocks.

For examples, see:

- “Add Logical Then and Logical Else Components” on page 3-18
- “Create the Body of the Report” on page 3-22

## **Format Control at the Component Level**

The output format and stylesheet that you select for a report determines most aspects of the generated report formatting. For details, see “Report Output Format and Stylesheet” on page 4-4.

In addition to stylesheets that control the format and layout of the report, for some components you can set properties to specify formatting details for that specific instance of a component. For example, for the `Simulink Property Table`, you can specify whether to display table borders or specify the alignment of text in table cells.

# Report Explorer

## About the Report Explorer

The *Report Explorer* is the MATLAB Report Generator and Simulink Report Generator graphical user interface (GUI). It allows you to:

- Create and modify report setup files.
- Apply stylesheets to format the generated report.
- Specify the report file format.
- Generate reports.

To open the Report Explorer, enter `report` in the MATLAB Command Window.

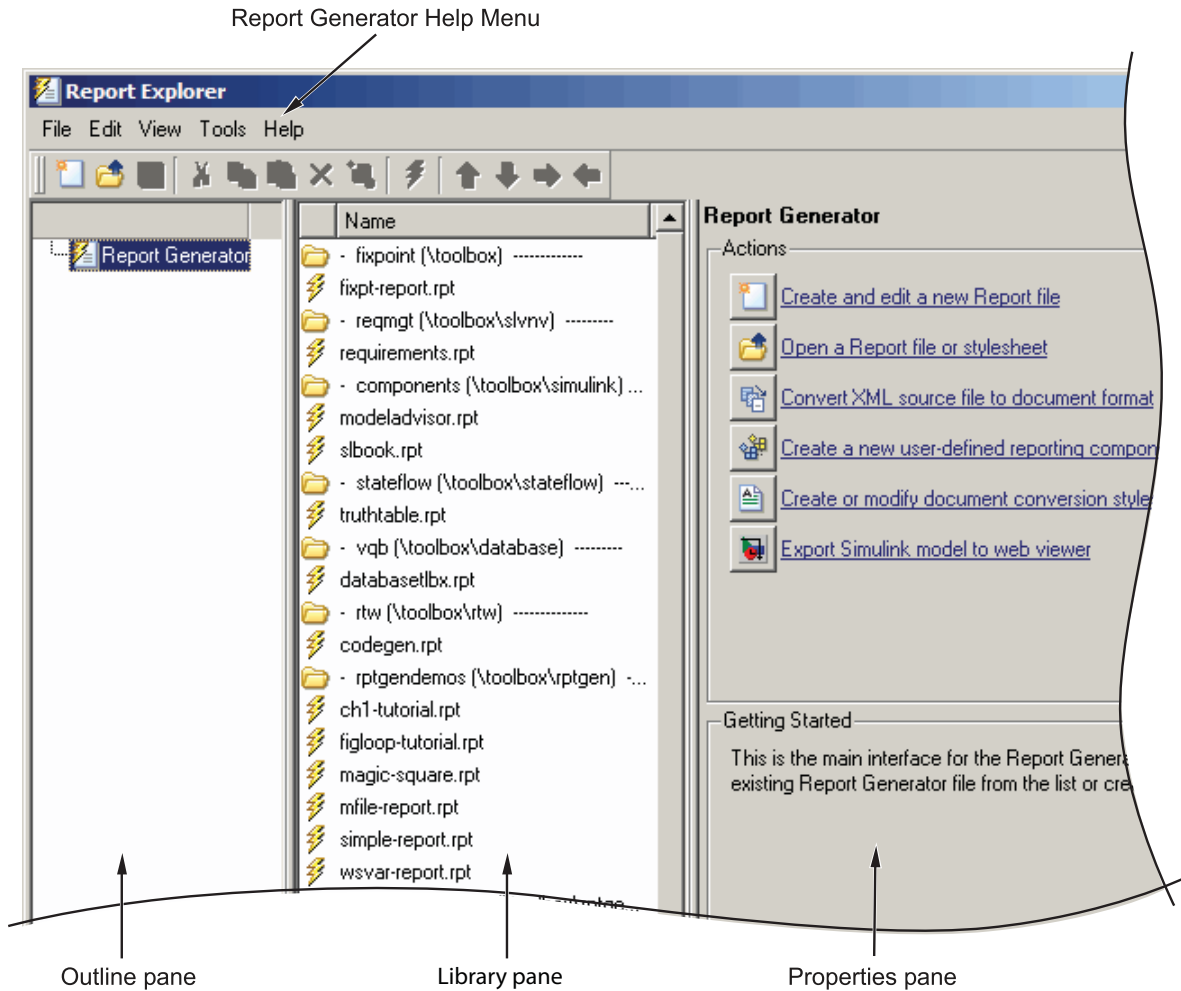

The Report Explorer has three panes:

- The *Outline pane* on the left shows the hierarchy of components in currently opened report setup files. Report components can reside within other report components, creating parent, child, and sibling relationships.
- The *Library pane* in the middle lists the objects available in the context of the Outline pane.

Outline Pane Context	Library Pane Contents
No report setup file is open.	Reports
Report setup file is open.	Components
Stylesheet is open.	Stylesheet attributes

- The *Properties pane* contents depend on the Outline pane context. If no report setup file is open, on the right displays tasks the Report Explorer can perform. If a report setup file is open, the Properties pane displays the properties for the item that is currently selected in the Library pane.

Outline Pane Context	Properties Pane Contents
No report setup file is open.	Tasks that the Report Explorer can perform
Report setup file is open.	Properties for the item that is currently selected  After you create a report setup file, the Properties pane initially displays properties for the report setup file as a whole.

---

**Tip** If the Report Explorer window opens with only two panes, one of the panes is hidden. You can move the vertical boundaries between the panes to reveal any hidden pane, or to make visible panes wider or narrower.

---

## How Simulink Report Generator and Simulink Software Interact

The Simulink and Simulink Report Generator software interact to create reports and Web views. The following table describes these interactions.

User Interface	Interaction with Simulink Report Generator software	Description
Report Explorer	The Report Explorer is the Simulink Report Generator graphical user interface (GUI). For more information, see “Report Explorer” on page 1-15.	Use the Report Explorer to edit existing report setup files, components, stylesheets, and attributes, or to customize your own.
Simulink model window	<p>Use Simulink model window to:</p> <ul style="list-style-type: none"> <li>• Export the model to a Web view</li> <li>• Generate a System Design Description report</li> <li>• Start the Report Explorer to export the model to a Web view or create and generate a report</li> </ul>	<p>Use the Simulink model window to:</p> <ul style="list-style-type: none"> <li>• Create reports that incorporate the current Simulink model</li> <li>• Export the model to a Web view</li> </ul> <p>For more information, see “Web Display of Model Information” and “Generate a System Design Description” on page 2-7.</p>

Simulink Report Generator software also interacts with Simulink Coder and Stateflow software.

Use report generation capabilities with the Simulink Coder software to:

- Create Adobe® Acrobat® PDF and Microsoft Word documents for generated code.

Use report generation capabilities with the Stateflow software to:

- Take snapshots of charts.
- Describe truth tables.
- Document chart hierarchy.



- Document object properties.

## Supported Report Formats

When the report generation process first creates a report, it generates a DocBook XML source file. You can customize this XML as needed. For more information, see the OASIS DocBook TC Web page at <http://www.oasis-open.org/committees/docbook> and <http://www.docbook.org/tdg/en/html/docbook.html>.

Next, the report generation process converts the XML source to one of these user-specified report formats:

- Rich Text Format (RTF)
- Hypertext Markup Language (HTML)
- Microsoft Word (.doc)
- Adobe Acrobat PDF

---

**Note** PDF reports only support bitmap (.bmp), jpeg (.jpg), and Scalable Vector Graphics (.svg) images.

---

## Browser Requirements for Web Views

Web views require a Web browser that supports Scalable Vector Graphics (SVG). Web views use SVG to render and navigate models.

MathWorks recommends the following Web browsers:

- Mozilla Firefox Version 1.5 or later, which has native support for SVG. To download the Firefox browser, see <http://www.mozilla.com/>.
- The Microsoft Internet Explorer® Web browser with the Adobe SVG Viewer plug-in. To download the Adobe SVG Viewer plug-in, see <http://www.adobe.com/svg/>.

---

**Note** The Microsoft Internet Explorer Web browser on Japanese systems does not support web views.

---



# Examples

---

Use this list to find examples in the documentation.

## **Creating Reports**

Chapter 3, “Creating Simulink Reports”

“Compare Simulink Model XML Files” on page 7-2

## **Generating Reports from MATLAB Files**

Generate Reports from MATLAB® Files on page 4-20

## **Creating Web Views**

“Create Web Views of Simulink Models” on page 5-11



## **Working with Components**

“Property Table Components” on page 6-6

“Summary Table Components” on page 6-17

“Dynamic Reporting Components” on page 6-22

Generating Reports on Specified Systems and their Subsystems on page 9-60

Temporarily Omitting a Model from a Loop on page 9-65



# Generate System Design Description Reports

---

- “System Design Description” on page 2-2
- “Generate a System Design Description” on page 2-7
- “Customize the System Design Description” on page 2-10

# System Design Description

In this section...
“Predefined Standard Reports” on page 2-2
“What Is the System Design Description?” on page 2-3
“What You Can Do with the Report” on page 2-3
“Report Contents” on page 2-3

## Predefined Standard Reports

From the Simulink Model Editor, you can access two predefined, standard Simulink Report Generator reports called:

- System Design Description
- Design Requirements

The System Design Description report provides summary or detailed information about a system design represented by a model. You can choose report options using the report dialog, or you can create a customized version using the Report Explorer. For details, see “Generate a System Design Description” on page 2-7.

You can use the System Design Description report setup file as a starting point for creating a setup file for your own report.

You can also generate an HTML model report for Stateflow charts. For details, see “Generate a Model Report”.

The Design Requirements report requires that you have the Simulink Verification and Validation product installed. The Design Requirements report includes information about all the requirements associated with the model and its objects. For details, see “Creating and Customizing a Requirements Report” in the Simulink Verification and Validation documentation.

## What Is the System Design Description?

The System Design Description is a prebuilt Simulink Report Generator report that describes the system design represented by a Simulink model.

By default, the Simulink Report Generator generates the report for the model from which you invoke the System Design Description report option.

## What You Can Do with the Report

You can use the System Design Description to

- Review a system design without having the model open
- Generate summary and detailed descriptions of the design
- Assess compliance with design requirements
- Archive the system design in a format independent of the modeling environment
- Build a customized version of the report, using the Report Explorer

---

**Note** To view step-by-step tutorials for creating and generating a report, see the Introduction to System Design Description Reports example.

---

## Report Contents

You can specify what kinds of information to include in the report, in terms of:

- What elements of a model to include in the report (for example, whether to include subsystems from custom libraries)
- Whether to generate a summary version or a detailed version of the System Design Description report.

For details, see “Generate a System Design Description” on page 2-7.

## Summary Version

Section	Information
Report Overview	Model version
Root System	<ul style="list-style-type: none"><li>• Block diagram representing the algorithms that compute root system outputs</li><li>• Description (if available from model)</li><li>• Interface: name, data type, and other properties of the system input and output signals</li><li>• Subsystems: the path and a block diagram for each subsystem</li><li>• State charts</li><li>• Requirements (optional)</li></ul>
Subsystems	<ul style="list-style-type: none"><li>• Path</li><li>• Block diagram</li></ul>
System Design Variables	<ul style="list-style-type: none"><li>• Design variables</li><li>• Functions in design variable expressions</li></ul>

## Detailed Version

The detailed version of the report includes all the information that is in the summary form of the report, as well as more information about the system components. The atomic subsystem information is more detailed than virtual subsystem information.

<b>Section</b>	<b>Information</b>
Report Overview	Model version
Root system	<ul style="list-style-type: none"> <li>• Block diagram representing the algorithms that compute root system outputs</li> <li>• Description (if available from model)</li> <li>• Interface: name, data type, and other properties of the root system input and output signals</li> <li>• Block parameters <ul style="list-style-type: none"> <li>▪ Includes detailed information about MATLAB Function blocks</li> </ul> </li> <li>• Block execution order for root system and atomic subsystems</li> <li>• Look-up tables</li> <li>• Simulink workspace variables</li> <li>• Model configuration sets</li> <li>• State charts</li> <li>• Requirements (optional)</li> </ul>
Subsystems	<p>The same type of information as the information for the root system, as well as:</p> <ul style="list-style-type: none"> <li>• Path of the subsystem in the model</li> <li>• (For atomic subsystems) Checksum that indicates whether the version of an atomic subsystem that generates the report differs from other versions of the subsystem</li> <li>• Referenced models (optional)</li> <li>• Subsystems from custom libraries (optional)</li> </ul>
State Charts	<ul style="list-style-type: none"> <li>• State chart</li> <li>• States</li> </ul>

Section	Information
	<ul style="list-style-type: none"><li>• Transitions between the states</li><li>• Junctions</li><li>• Events that trigger state transitions</li><li>• Data types</li><li>• Targets</li><li>• Truth tables</li></ul>

### **Report Captures Documentation Included in a Model**

The System Design Description reports documentation included in a model, including:

- The model description (from the model properties)
- The block property Description
- DocBlock model documentation blocks

To enrich the generated System Design Description, consider adding descriptive information in a model in these ways listed above.



## Generate a System Design Description

In this section...
“Open the System Design Description Dialog Box” on page 2-7
“Choose System Design Description Options” on page 2-7

### Open the System Design Description Dialog Box

To open the System Design Description dialog box:

- 1 Open the model or subsystem for which you want to generate a report.
- 2 From the Simulink Model Editor **File** menu, select **Reports > System Design Description**. The System Design Description dialog box opens
- 3 Specify layout and content options for the report. For details, see “Choose System Design Description Options” on page 2-7.
- 4 Click the **Generate**

### Choose System Design Description Options

You can specify options for layout and content, for the following items:

- Title page contents
- Report content
- Report file format and storage location

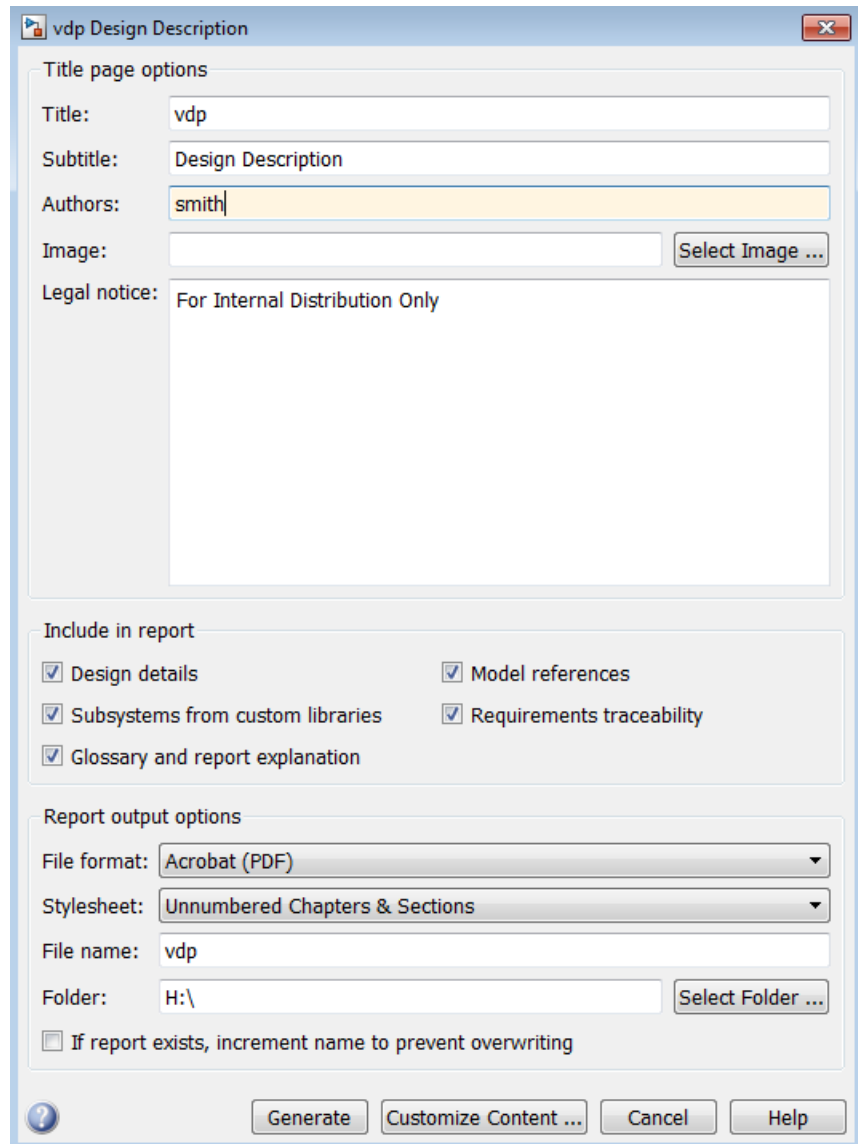

In the dialog box, to display detailed information about each option, right-click on the option prompt and select the **What's This** context-sensitive help.

To create a customized version of the report, click the **Customize Content** button. The customize option creates a copy of the report setup file and opens the copy in the Report Explorer. See “Customize the System Design Description” on page 2-10.

# Customize the System Design Description

### In this section...

“Using the Report Explorer to Customize the Report” on page 2-10

“Building a Dialog Box for a Custom Report Setup File” on page 2-11

You can create customized versions of the System Design Description report by using the Report Explorer and, optionally the MATLAB tools for building graphical user interfaces.

By default, when you open a customized version of the report, the System Design Description dialog box does not open.

## Using the Report Explorer to Customize the Report

To customize the System Design Description setup file in the Simulink Report Generator using the Report Explorer:

- 1 In the System Design Description dialog box, click the **Customize Content** button to open the Report Explorer.

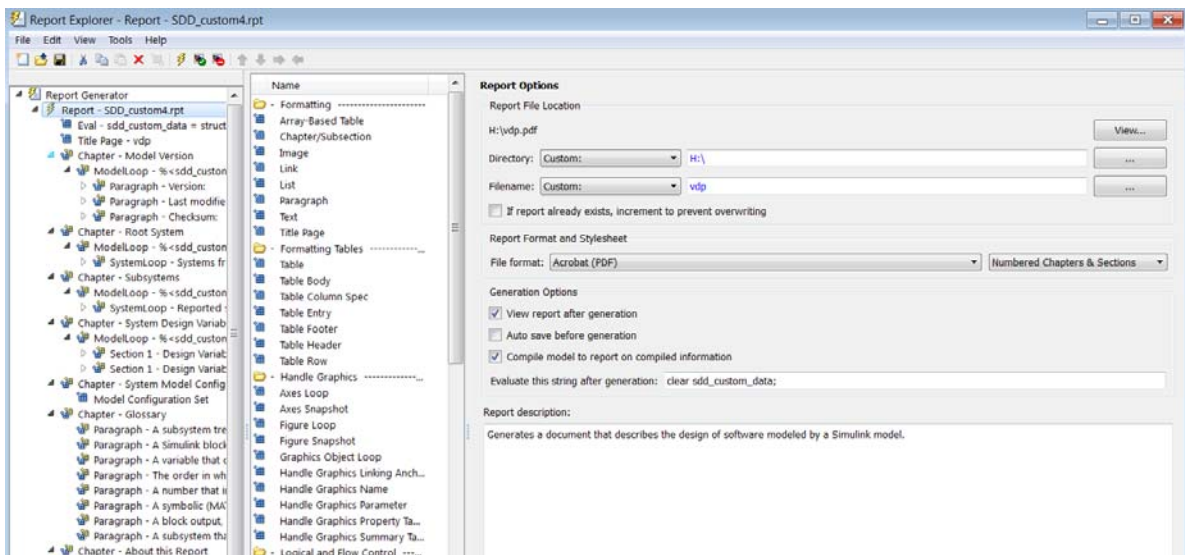

The Report Explorer reflects any changes (for example, a different report name) that you made in the System Design Description dialog box.

- 2 In the Report Explorer, add or modify components. See “Add Components” and “Information Components”.

- Do not remove the `sdd_custom_data` structure, which is defined as:

```
sdd_custom_data = struct('model',bdroot,'rootSystem',gcs);
```

You can modify the `model` argument, which is the model for which you generated the report and the `rootSystem` argument, which is the system level in the model at which, and below which, you want to use to generate the report.

- Do not remove or modify functions that begin with `StdRpt`, such as `%StdRpt.getChecksum`

- 3 Optionally modify a style sheet (see “Layout Stylesheets”).

- 4 Save the customized report with a name other than `SDD_custom.rpt`.

## **Building a Dialog Box for a Custom Report Setup File**

To provide options for your custom report, you can create a dialog box, like the System Design Description dialog box. The dialog box that you create for your custom report can allow others to adapt the report to meet their needs, without their having to use the Report Explorer.



# Creating Simulink Reports

---

- “Create a Simulink® Report Generator™ Report” on page 3-2
- “Report Options” on page 3-3
- “Add Components to the Report Setup File” on page 3-5
- “Error Handling for MATLAB Code” on page 3-53
- “Generate the Report” on page 3-55

# Create a Simulink Report Generator Report

This example involves the following tasks:

- Inserting models and scopes into reports
- Creating tables in reports using workspace data
- Evaluating MATLAB expressions
- Inserting values of workspace variables into reports
- Creating reports with chapters and subsections
- Running loops and flow control
- Handling errors

It shows you how to use the Report Explorer to design a report setup file and generate a report that does the following:

- Opens a Simulink model for the van der Pol equation, called the `vdp_model`.
- Sets the `Gain` parameter for the `Mu` block to five different values.
- Simulates the model each time the `Gain` parameter is set.
- Collects the results. Results that fall within a specified range appear in a table in the generated report.

You do not need to know MATLAB or Simulink software to run this tutorial. However, knowledge of these products might be helpful for understanding the MATLAB code and model simulation that executes.

This tutorial includes separate sections for different kinds of report creation and generation task. Each section builds on the previous sections. However, if you want to work through a later section without having done the previous sections, in MATLAB you can view the completed report setup file: open `Dynamic Simulink Report`. The report is for the `vdp` model.

---

**Note** For another set of step-by-step tutorials for creating and generating a report, see the `Introduction to System Design Description Reports` example.

---



## Report Options

To create and configure the report setup file:

- 1** Start a Simulink software session.
- 2** Open the Report Explorer by clicking **Tools > Report Generator** in the Simulink model window menu bar.
- 3** Select **File > New** to create a report setup file.
- 4** Save the report setup file.

In the Properties pane:

- a** Specify where to save the report setup file. To save it in the current working folder, select **Present Working Directory** from the **Directory** selection list.
- b** Specify the report format. In the **File format** selection list, select **Acrobat (PDF)**.
- c** Enter a description for the report. In the **Report description** text box, replace the existing contents with the following text.

---

**Tip** Copy and paste this code from the HTML documentation into the Report Explorer.

---

### Simulink Dynamic Report

This report opens up a model, sets a block parameter several times, simulates the model, and collects the results. Results that fall within a specified range are displayed in a table after the test is complete.

The report is configured to test the vdp model only. By selecting the Eval String component immediately below the Report component, you can modify

```
* model  
* block
```

- \* parameter
- \* tested values

**5** Click **File > Save As** to save the report setup file as `simulink_tutorial.rpt`.

The Outline pane on the left displays the new file name.

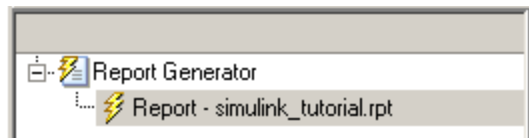

## Add Components to the Report Setup File

### In this section...

- “Report Components” on page 3-5
- “Add MATLAB Code” on page 3-7
- “Add a Title Page” on page 3-13
- “Open the Simulink Model” on page 3-15
- “Add Logical Then and Logical Else Components” on page 3-18
- “Error If Model Cannot Be Opened” on page 3-19
- “Create the Body of the Report” on page 3-22
- “Process with a Model Loop Component” on page 3-23
- “Add a Paragraph for Each Model” on page 3-25
- “Insert a Snapshot of the Model” on page 3-27
- “Add a Loop for Processing the Model” on page 3-28
- “Block Parameter Value from a MATLAB Expression” on page 3-30
- “Create a Section for Each Iteration” on page 3-32
- “Insert the Block Value” on page 3-33
- “Set a Parameter Value” on page 3-34
- “Check Value Using a Logical If Component” on page 3-36
- “Simulate the Model Using a Model Simulation Component” on page 3-39
- “Create a Post-Test Analysis Section” on page 3-45

### Report Components

Report *components* specify what information to include in the report. Components are self-contained, modular MATLAB objects that control the report-generation process and insert elements, such as tables, lists, and figures, into a report setup file. Use components to customize the appearance and output of reports.

For more information, see “Report Components” on page 1-10.

The following figure shows a sample page from the report you create in this tutorial, and which components you use to produce this output.

**Note** Do not deactivate report components that you add to the report setup file.

Chapter/Subsection component — **Chapter 1. Model - vdp**

Paragraph component — This report demonstrates Simulink Report Generator's ability to experiment with Simulink systems and auto-document the results. In this report, you load the model vdp and simulate it length times. This report modifies the vdp/Mu block's "Gain" value, setting it to the values [-1 0 0.5 1 2] . Each iteration of the test includes a set of scope snapshots in the report.

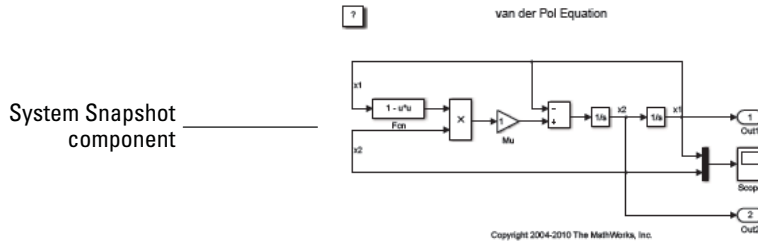

Chapter/Subsection component — **Processing the vdp model**

Insert Variable component — `Iteration_Value . -1`

Figure 1.1. Scope

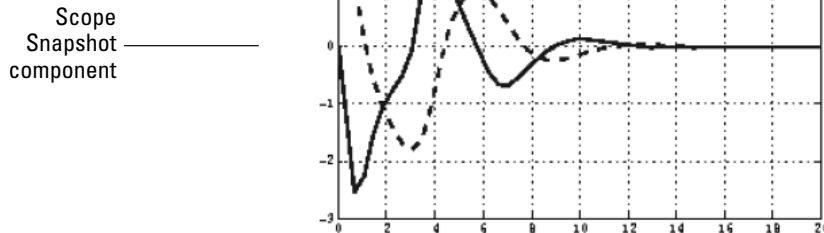

---

## Add MATLAB Code

**Note** This section builds on the step-by-step tutorial presented in “Create a Simulink® Report Generator™ Report” on page 3-2.

To see the completed report setup file, open Simulink Dynamic Report. The report is for the vdp model.

---

The first component to add is the Evaluate MATLAB Expression component, which evaluates MATLAB commands in the workspace. The code in this component assigns initial values to variables used in this tutorial.

- 1 In the Outline pane on the left, select `simulink_tutorial.rpt`.

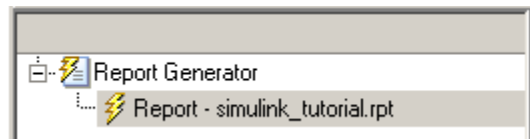

- 2 In the Library pane in the middle, under the MATLAB category, select Evaluate MATLAB Expression.

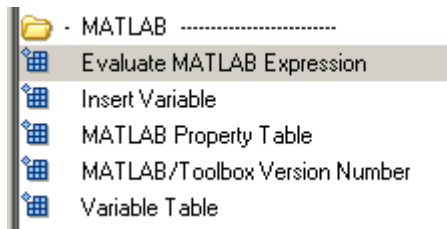

- 3 In the Properties pane on the right, click the icon next to **Add component to current report** to insert the component into the report.

---

**Note** You cannot edit the component information in the Properties pane on the right until you add the component to the report.

---

In the Outline pane on the left, the Evaluate MATLAB Expression component appears under the `simulink_tutorial` report setup file. The Simulink Report Generator software abbreviates the component name to `Eval`.

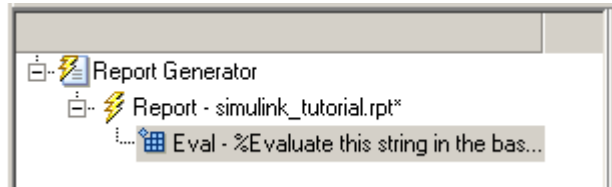

The icon in the upper-left corner of the `Eval` component's icon indicates that this component cannot have child components. By default, any components you add while the `Eval` component is selected are siblings of this component.

The options for the Evaluate MATLAB Expression component appear in the Properties pane on the right.

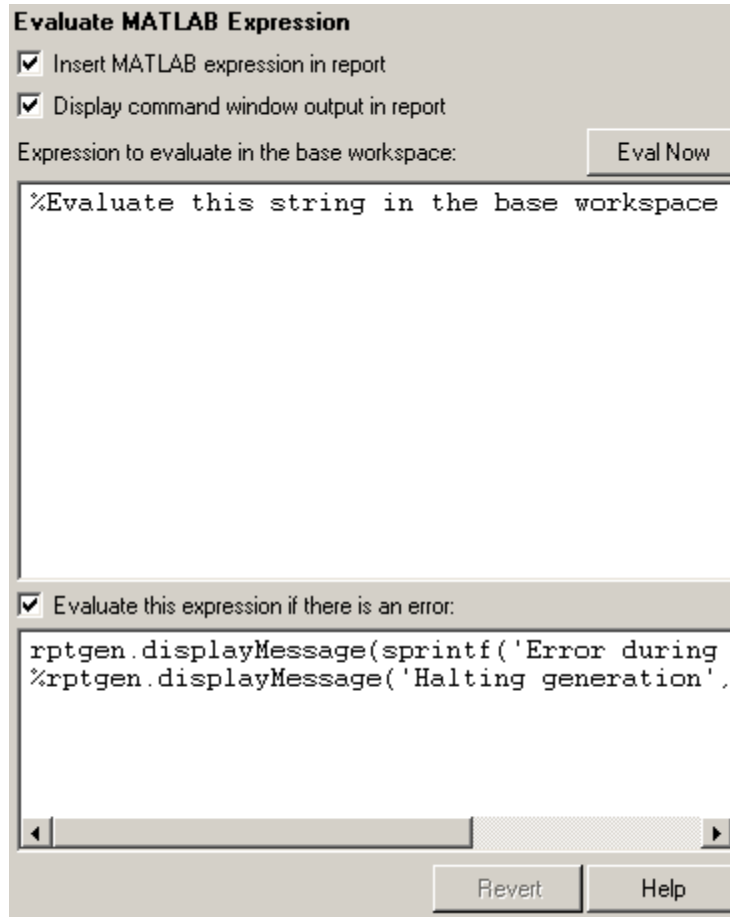

- 4** Clear the **Insert MATLAB expression in report** and the **Display command window output in report** check boxes so you do not include MATLAB code or output in this report.
- 5** Add MATLAB code to the **Expression to evaluate in the base workspace** text box to specify the following values:
  - The model name
  - The block name
  - The block parameter

- Parameter values
  - Other initial values required for processing the vdp model
- Replace the existing text with the following MATLAB code.

```
%The name of the model
%that will be changed
expModel='vdp';

%The name of the block in the model
%that will be changed
expBlock='vdp/Mu';

%The name of the block parameter
%that will be changed
expParam='Gain';

%The values that will be set
%during experimentation
expValue=[-1 0 .5 1 2];

%expValue can be either a vector
%or a cell array

testMin=2.1;
testMax=3;

%---- do not change code below line ---

try
    open_system(expModel);
end

expOkValues=cell(0,2);
```



---

**Note** When you change a field in the Properties pane on the right, the field background changes color (the default is a cream color), indicating that there are unapplied changes to that field. As soon as you perform operations on another component, the Simulink Report Generator software applies the changes, and the background color becomes white again.

---

- 6** Select the **Evaluate this expression if there is an error** check box.
- 7** In the field under the check box, replace the existing text with the following text:

```
disp(['Error during eval: ', evalException.message])
```

The Report Explorer window now looks as follows.

**Evaluate MATLAB Expression**

Insert MATLAB expression in report

Display command window output in report

Expression to evaluate in the base workspace: Eval Now

```
%The name of the model
%that will be changed
expModel='vdp';

%The name of the block in the model
%that will be changed
expBlock='vdp/Mu';

%The name of the block parameter
%that will be changed
expParam='Gain';

%The values that will be set
%during experimentation
expValue=[-1 0 .5 1 2];

%expValue can be either a vector
%or a cell array

testMin=2.1;
testMax=3;

%---- do not change code below line ----
```

Evaluate this expression if there is an error:

```
disp(['Error during Eval: ', evalException.message])
```

Revert    Help

---

**Tip** To run the commands that you specified in your MATLAB expression, click the **Eval Now** button. This button is located at the upper-right corner of the Report Explorer. This is an easy way to ensure that your commands are correct and will not cause report generation problems.

---

**8** Click **File > Save** to save the report setup file.

For information about handling error conditions, see “Error Handling for MATLAB Code” on page 3-53.

## Add a Title Page

---

**Note** This section builds on the step-by-step tutorial presented in “Create a Simulink® Report Generator™ Report” on page 3-2.

To see the completed report setup file, open Simulink Dynamic Report. The report is for the vdp model.

---

Create a custom title page for your report using the Title Page component.

**1** In the Outline pane on the left, select the Eval component.

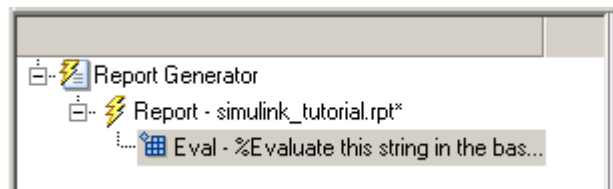

**2** In the Library pane in the middle, under the Formatting category, click Title Page.

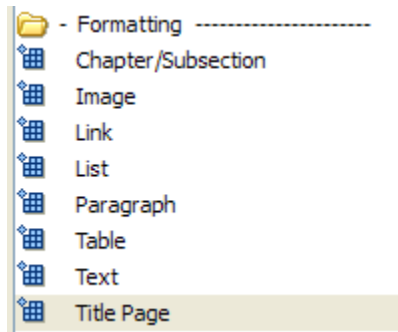

- 3** Click the icon next to **Add component to current report**.

The **Title Page** component appears in the Outline pane.

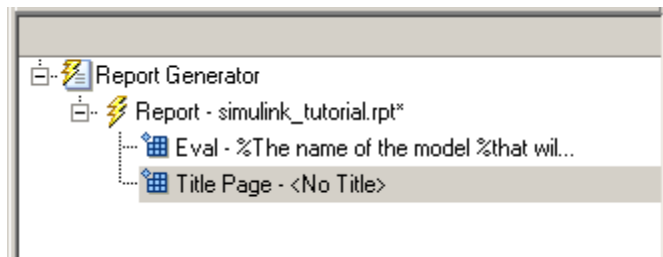

---

**Note** To use the **Title Page** component, you need to have a **Chapter** component in your report. You have not yet added a **Chapter** component, so the **Properties** pane displays a message indicating that chapters are required for the **Title Page** component to appear correctly. Because later in this tutorial you add **Chapter** components to this report, you can ignore that message.

---

- 4** In the **Properties** pane on the right:
  - a** In the **Title** text box, enter:  
Dynamic Simulink Report
  - b** In the **Subtitle** text box, enter:

### Using Simulink Report Generator to Document Changes

- c** In the **Options** section, choose Custom Author from the selection list.
- d** Enter your name in the text box.
- e** Select the **Include report creation date** check box.
- f** Select the default date and time format from the selection list. The Properties pane on the right looks as follows.

**Title Page**

Error

⚠ Chapters are required for component "Title Page" (section) to appear correctly. Add chapters to template.

Main Image Abstract Legal notice

Title

Title: Dynamic Simulink Report

Subtitle: Using Report Generator to Document Changes

Options

Custom author: John Q. Engineer

Include report creation date: dd-mmm-yyyy HH:MM:SS (26-Jul-2011 09:36:58)

Include copyright holder and year:

Display legal notice on title page

- 5** Save the report setup file.

## Open the Simulink Model

**Note** This section builds on the step-by-step tutorial presented in “Create a Simulink® Report Generator™ Report” on page 3-2.

To see the completed report setup file, open Simulink Dynamic Report. The report is for the vdp model.

The following statement in the Evaluate MATLAB Expression component that you created in “Add MATLAB Code” on page 3-7 tries to open the vdp model:

```
try
    open_system(expModel);
end
```

---

**Tip** Select the Eval component in the Outline pane on the left to look at this code again.

---

To see if the vdp model was successfully opened, test the result of the open\_system command using a Logical If component.

- 1 In the Outline pane on the left, select the Title Page component.
- 2 In the Library pane in the middle, under the Logical and Flow Control category, select Logical If. This component checks to see if a given condition is true or false; in this case, if the model opened successfully.

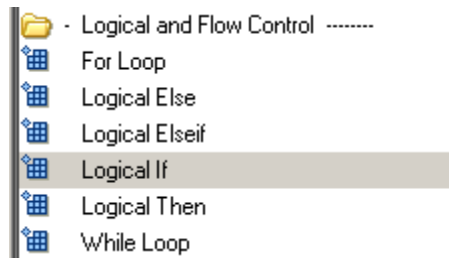

- 3 In the Properties pane on the right, click the icon next to **Add component to current report**. The Logical If component appears as if in the Outline pane.

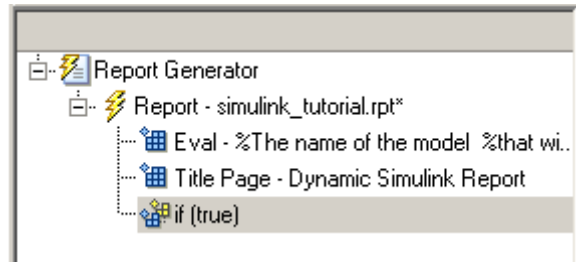

These components are child components of the report and siblings of one another. Components can have parent, child, and sibling relationships.

This component can have child components. “Add Logical Then and Logical Else Components” on page 3-18 explains how to add two child components to the `if` component.

- 4 In the Properties pane on the right, in the **Test expression** text box, replace the default text, `true`, with the following text:

```
strcmp(bdroot(gcs),expModel)
```

The `strcmp` function compares the name of the open Simulink model and the value of `expModel`, which was set to `'vdp'`. It tests to see if the `vdp` model opened successfully. `strcmp` returns 1 (`true`) if the two strings match, and 0 (`false`) if not.

- 5 Save the report setup file.

The `if` component name in the Outline pane changes to include the expression that you added.

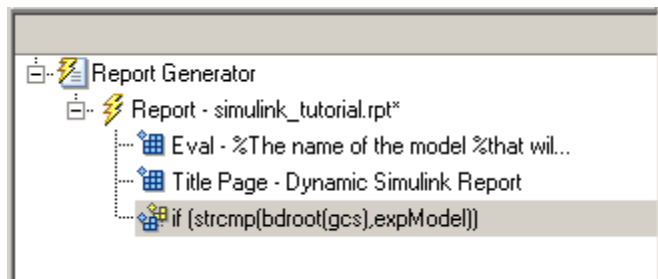

## Add Logical Then and Logical Else Components

**Note** This section builds on the step-by-step tutorial presented in “Create a Simulink® Report Generator™ Report” on page 3-2.

To see the completed report setup file, open Simulink Dynamic Report. The report is for the vdp model.

The `if strcmp(bdroot(gcs), expModel)` component has two possible results. Add two child components to the report setup file to process these cases.

- 1 In the Outline pane on the left, select the `if` component.

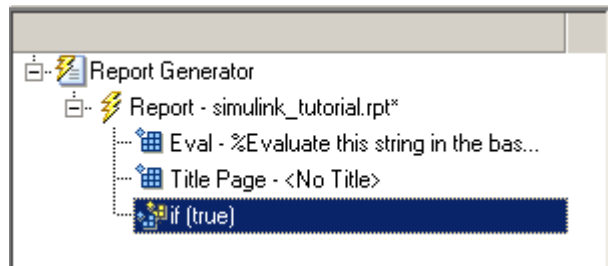

- 2 In the Library pane in the middle, under the Logical and Flow Control category, double-click Logical Then.
- 3 In the Outline pane on the left, select the `if` component again.
- 4 In the Library pane in the middle, under the Logical and Flow Control category, double-click Logical Else.

Both elements are added as child components to the `if` component, as shown in the Outline pane.



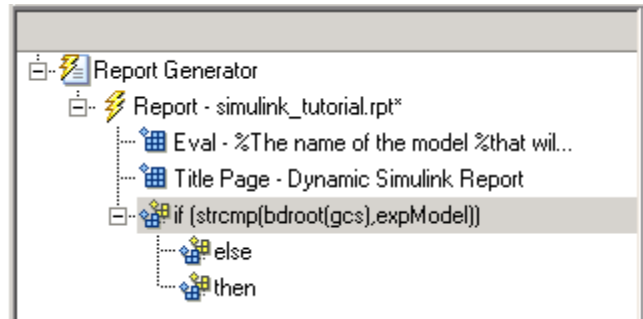

- 5** To move the else component under the then component, select the else component and click the **down** arrow on the toolbar once. The Outline pane on the left looks as follows.

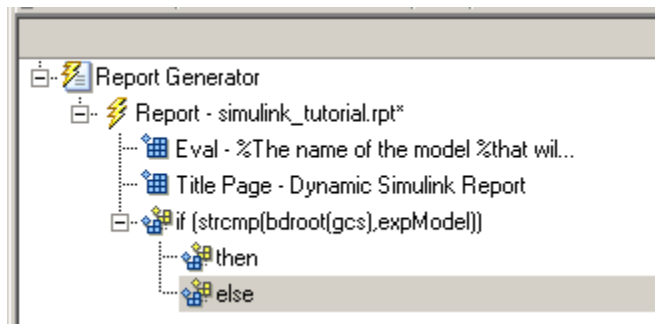

- 6** Save the report setup file.

## Error If Model Cannot Be Opened

---

**Note** This section builds on the step-by-step tutorial presented in “Create a Simulink® Report Generator™ Report” on page 3-2.

To see the completed report setup file, open Simulink Dynamic Report. The report is for the vdp model.

---

If the `if strcmp(bdroot(gcs), expModel)` component fails (the vdp model cannot open), the `else` component executes. Display an error message in the report using the Chapter/Subsection component.

- 1 In the Outline pane on the left, select the `else` component.

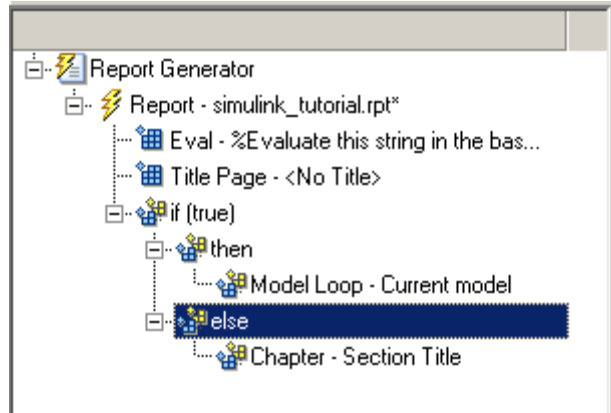

- 2 In the Library pane in the middle, under the Formatting category, double-click Chapter/Subsection to add it as a child of the `else` component. This component displays an error message if an error occurs when opening the vdp model.

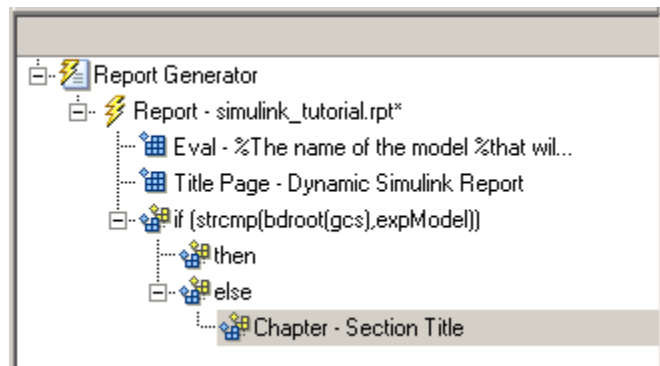

---

**Note** When you add a component to a report, it is added by default as a child component unless the selected component cannot have child components.

---

- 3 In the Properties pane on the right, choose **Custom** from the **Title** selection list, and then enter the following text in the text box:

Load Model Failed.

Save the report file.

The Outline pane looks as follows.

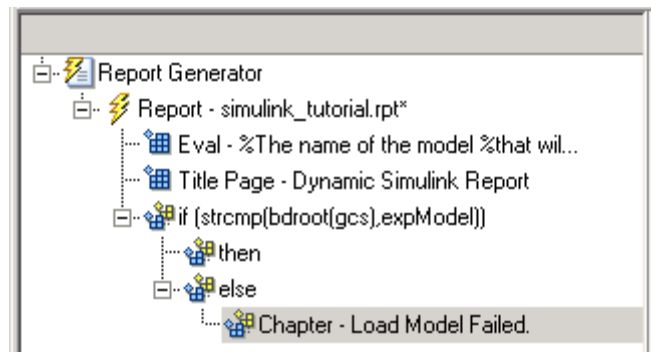

- 4 In the Outline pane on the left, select the Chapter component.
- 5 In the Library pane in the middle, under **Formatting**, double-click **Paragraph**.
- 6 In the Properties pane on the right, enter the following text in the **Paragraph Text** text box to display the following error message:

Error: Model %<expModel> could not be opened.

The expression %<expModel> indicates that the value of the workspace variable `expModel` is inserted into the text, as in the following example.

Error: Model `vdp` could not be opened.

**7** In the Outline pane on the left, select the Chapter/Section component.

**8** Save the report setup file.

The Outline pane looks as follows.

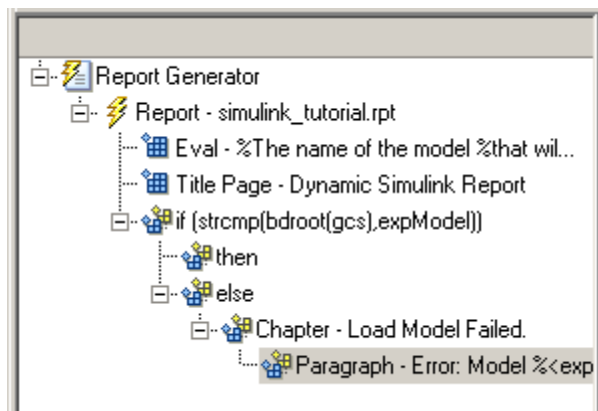

## Create the Body of the Report

---

**Note** This section builds on the step-by-step tutorial presented in “Create a Simulink® Report Generator™ Report” on page 3-2.

To see the completed report setup file, open Simulink Dynamic Report. The report is for the vdp model.

---

Creating the body of the report involves setting up components and code for dynamic execution of report components. In this example, you perform the following tasks:

- “Process with a Model Loop Component” on page 3-23
- “Add a Paragraph for Each Model” on page 3-25
- “Insert a Snapshot of the Model” on page 3-27
- “Add a Loop for Processing the Model” on page 3-28
- “Block Parameter Value from a MATLAB Expression” on page 3-30

- “Create a Section for Each Iteration” on page 3-32
- “Insert the Block Value” on page 3-33
- “Set a Parameter Value” on page 3-34
- “Check Value Using a Logical If Component” on page 3-36
- “Simulate the Model Using a Model Simulation Component” on page 3-39
- “Create a Post-Test Analysis Section” on page 3-45

Each action requires a separate component under the `then` component. For information about the `then` component in this report, see “Add Logical Then and Logical Else Components” on page 3-18.

## Process with a Model Loop Component

---

**Note** This section builds on the step-by-step tutorial presented in “Create a Simulink® Report Generator™ Report” on page 3-2.

To see the completed report setup file, open `Simulink Dynamic Report`.

---

The report changes the `Gain` parameter for the `Mu` block in the `vdp` model several times. This task requires a `Model Loop` component.

- 1** In the Outline pane on the left, select the `then` component.
- 2** In the Library pane in the middle, scroll down to the `Simulink` category, and then double-click `Model Loop`. It is added as a child of the `then` component.

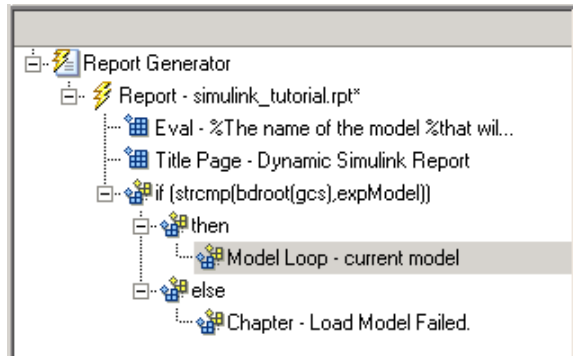

The Properties pane on the right looks as follows.

The screenshot shows the 'Model Loop' properties pane. It is divided into several sections:

- Help:** Includes specified models and systems in report.
- Models to Include:** A list box containing 'Current block diagram' with up, down, and delete icons.
- Model Options:**
  - Active
  - Model name: Current block diagram
  - Traverse model: All systems in model
  - Look under masks: Functional masks only
  - Follow library links: Do not follow library links
  - Model reference: Do not follow model reference blocks
  - Include all variants
  - Starting system(s): Model root
- Section Options:**
  - Create section for each object in loop
  - Display the object type in the section title
  - Create link anchor for each object in loop

- 3 In the Properties pane on the right:
  - a Select the **Active** check box to process the vdp model.
  - b In the **Traverse model** selection list, select **Selected system(s) only** to traverse only the vdp model.
  - c Select **Model root** from the **Starting system(s)** selection list.
  - d At the bottom of the Properties pane on the left, select the **Create section for each object in loop** check box to create a chapter or section for each model. When you select this check box, the component name in the Outline pane on the left changes to **Model Loop Chapter**.

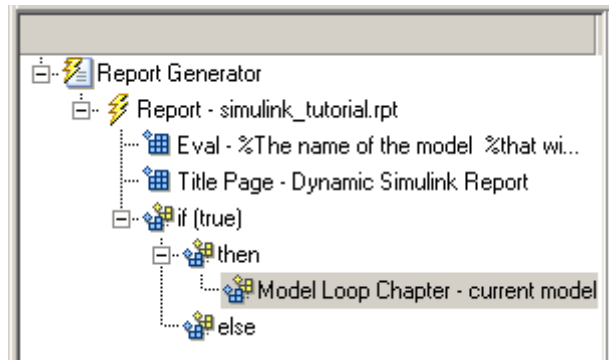

- e Select the **Display the object type in the section title** check box to include the object type (in this example, model) in the title name.
  - f Clear the **Create link anchor for each object in loop** check box.
- 4 Save the report setup file.

## Add a Paragraph for Each Model

---

**Note** This section builds on the step-by-step tutorial presented in “Create a Simulink® Report Generator™ Report” on page 3-2.

To see the completed report setup file, open Simulink Dynamic Report. The report is for the vdp model.

---

In each Model Loop Chapter, add an explanation using the Paragraph component.

- 1 In the Outline pane on the left, select the Model Loop Chapter component.
- 2 In the Library pane in the middle, scroll up to the Formatting category, and then double-click Paragraph. The Paragraph component is added as a child of the Model Loop Chapter component.

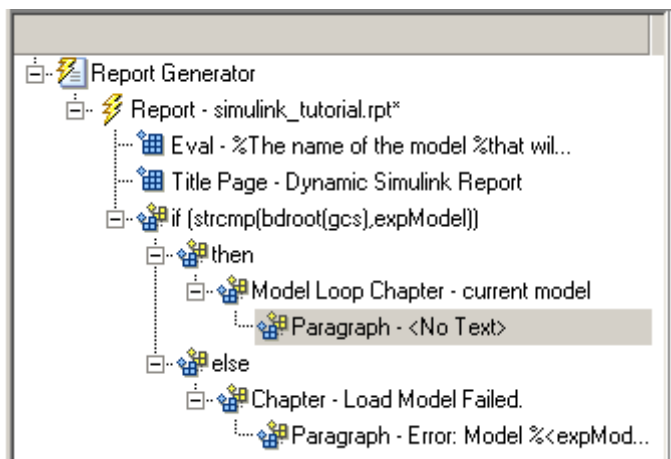

- 3 In the Properties pane on the right, in the **Paragraph Text** text box, enter the following text:

```
This report demonstrates Simulink Report Generator's ability to experiment with Simulink systems and auto-document the results. In this report, you load the model %<expModel> and simulate it %<length> times. This report modifies the %<expBlock> block's "%<expParam>" value, setting it to the values %<expValue>. Each iteration of the test includes a set of scope snapsnots in the report.
```

When this report is generated, the variable names preceded by percent signs (%) and enclosed in brackets (<>) are replaced with the values of those variables in the MATLAB workspace.

- 4 Save the report setup file.



## Insert a Snapshot of the Model

**Note** This section builds on the step-by-step tutorial presented in “Create a Simulink® Report Generator™ Report” on page 3-2.

To see the completed report setup file, open Simulink Dynamic Report. The report is for the vdp model.

Inside each Model Loop Chapter component, include a snapshot of the current model using the System Snapshot component.

- 1 In the Outline pane on the left, select the Model Loop Chapter component.
- 2 In the Library pane in the middle, scroll down to the Simulink category, and then double-click the System Snapshot component.

This component inserts an image of the current model into your report. The Properties pane on the right looks as follows.

The screenshot shows the 'System Snapshot' component's configuration interface. It is divided into two main sections: 'Snapshot' and 'Properties'.

**Snapshot Section:**

- Format:** A dropdown menu set to 'Automatic SL format'.
- Orientation:** A dropdown menu set to 'Portrait'.
- Scaling:** A dropdown menu set to 'Automatic'.
- Size:** A text input field containing '[7 9]' followed by the unit 'inches'.
- Units:** A dropdown menu set to 'Inches'.
- Max Size:** A text input field containing '[7 9]' followed by the unit 'inches'.
- Zoom:** A text input field containing '100' followed by a '%' symbol.

**Properties Section:**

- Include callouts to describe visible objects
- Use printframe

At the bottom of the pane is a button labeled 'Advanced >>'.

- 3 In the Properties pane on the right:

- a Select Zoom from the **Scaling** selection list.
  - b Enter 70 as the % value.
- 4 In the Outline pane on the left, select the System Snapshot component.
- 5 Click the **down** arrow on the toolbar once to move it under the Paragraph component.

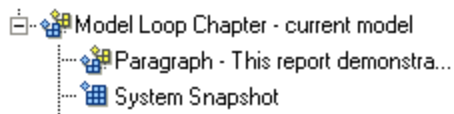

- 6 Save the report setup file.

### Add a Loop for Processing the Model

---

**Note** This section builds on the step-by-step tutorial presented in “Create a Simulink® Report Generator™ Report” on page 3-2.

To see the completed report setup file, open Simulink Dynamic Report. The report is for the vdp model.

---

Create a loop to process the model %length times using the For Loop component.

- 1 In the Outline pane on the left, select the System Snapshot component.
- 2 In the Library pane in the middle, under the Logical and Flow Control category, double-click For Loop. The For Loop component is added as a sibling of the System Snapshot component.

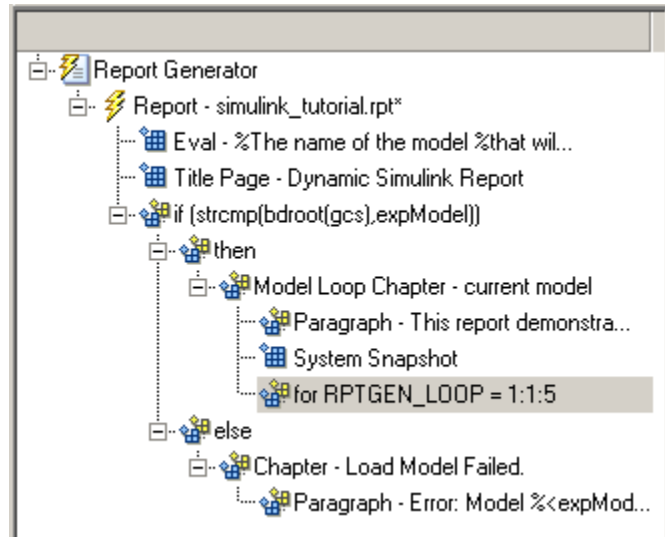

**3** In the Properties pane on the right:

- a** In the **End** text box, replace the existing text with the following text:

`length(expValue)`

`expValue` is the array of Gain parameter values assigned in the Eval component with the command `expValue=[ -1 0 0.5 1 2];`. The expression `length(expValue)` evaluates to 5 in this example.

- b** In the **Variable name** text box, replace the existing text with the name of the for loop variable. Enter the following text:

`expIteration`

The name of the For component in the Outline pane on the left changes to reflect the loop variable and the termination value.

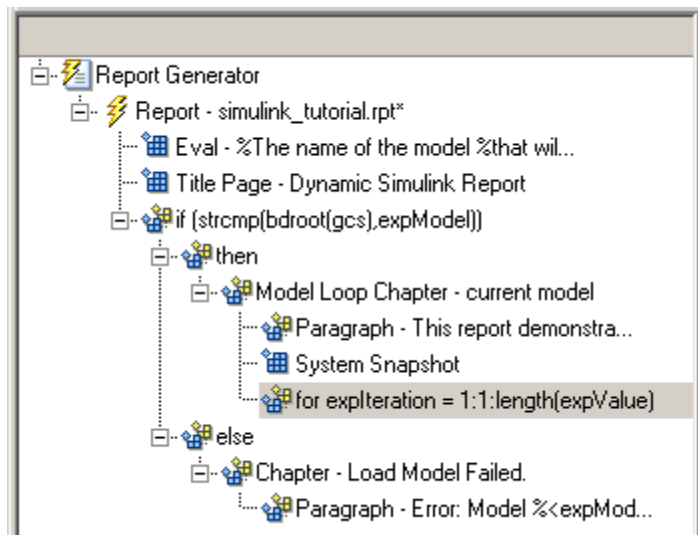

4 Save the report setup file.

## Block Parameter Value from a MATLAB Expression

**Note** This section builds on the step-by-step tutorial presented in “Create a Simulink® Report Generator™ Report” on page 3-2.

To see the completed report setup file, open Simulink Dynamic Report. The report is for the vdp model.

For each iteration, get a value from the expValue array to use as the Gain parameter value. This task requires an Evaluate MATLAB Expression component.

- 1 In the Outline pane on the left, select the for component.
- 2 In the Library pane in the middle, under the MATLAB category, double-click Evaluate MATLAB Expression. In the Outline pane, the component name is shortened to Eval.

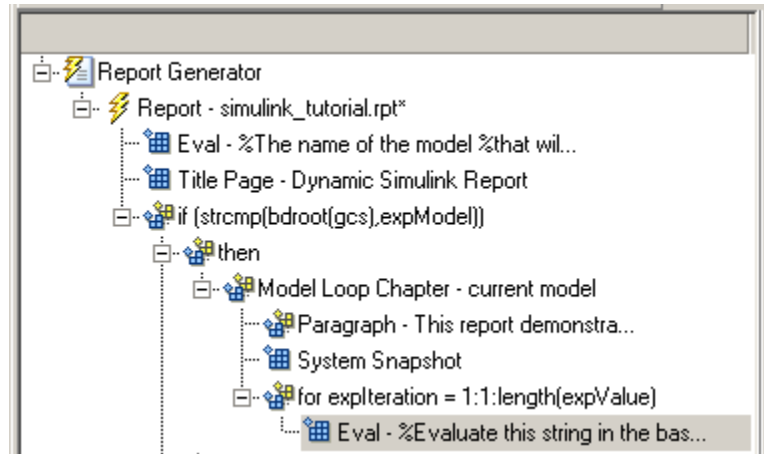

- 3 On the Properties pane on the right:
  - a Clear the **Insert MATLAB expression in report** and **Display command window output in report** check boxes.
  - b Enter the following text in the **Expression to evaluate in the base workspace** text box:

```
%Evaluate this string in the base workspace

if iscell(expValue)
    Iteration_Value=expValue{expIteration};
else
    Iteration_Value=...
        num2str(expValue(expIteration));
end
```

The `Iteration_Value` variable represents the designated array element.

- c Clear the **Evaluate expression if there is an error** check box.
- 4 Save the report setup file.

## Create a Section for Each Iteration

**Note** This section builds on the step-by-step tutorial presented in “Create a Simulink® Report Generator™ Report” on page 3-2.

To see the completed report setup file, open Simulink Dynamic Report. The report is for the vdp model.

Create a separate section for each iteration of the loop that includes the data using the Chapter/Subsection component.

- 1 In the Outline pane on the left, under the for component, select the Eval component.
- 2 In the Library pane in the middle, under the Formatting category, double-click the Chapter/Subsection component to add it as a sibling. This component is automatically added as Section 1 because it is inside a Chapter component (the Model Loop Chapter component).

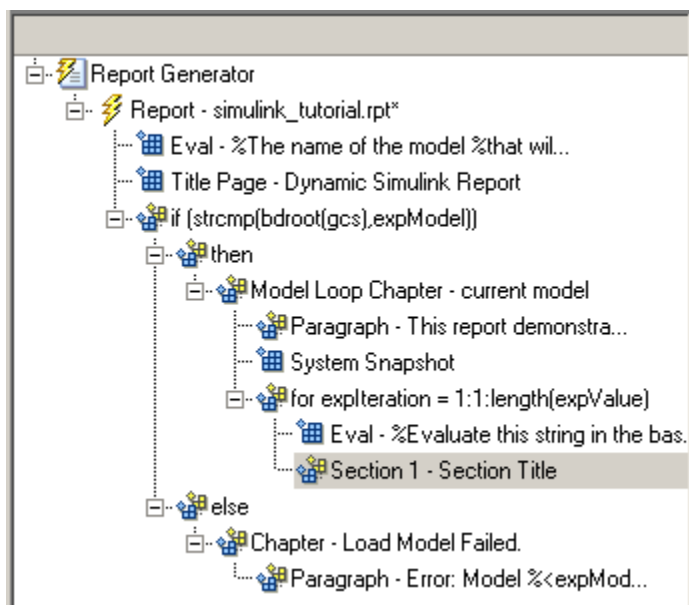

- 3** In the Properties pane on the right:
  - a** In the **Title** selection list, select **Custom**.
  - b** In the text box, enter the following title:

Processing the vdp model

This indicates that the section title comes from the first child component. Do not change any other properties.

- 4** Save the report setup file.

## Insert the Block Value

---

**Note** This section builds on the step-by-step tutorial presented in “Create a Simulink® Report Generator™ Report” on page 3-2.

To see the completed report setup file, open Simulink Dynamic Report. The report is for the vdp model.

---

Insert the Gain value that is used for each simulation.

- 1** In the Outline pane on the left, select the **Section 1** component.
- 2** In the Library pane in the middle, under the **MATLAB** category, double-click **Insert Variable**.
- 3** In the Properties pane on the right:
  - a** In the **Variable name** text box, enter `Iteration_Value`.
  - b** In the **Display as** selection list, select **Paragraph**.  
The Properties pane on the right looks as follows.

**Insert Variable**

Source

Variable name:

Variable location:

"Iteration\_Value" not found in workspace.

Display options

Title:

Array size limit:

Object depth limit:

Object count limit:

Display as:

Show variable type in headings

Show variable table grids

Make variable table page wide

Omit if value is empty

Omit if property default value

**4** Save the report setup file.

## Set a Parameter Value

---

**Note** This section builds on the step-by-step tutorial presented in “Create a Simulink® Report Generator™ Report” on page 3-2.

To see the completed report setup file, open Simulink Dynamic Report. The report is for the vdp model.

---

For each iteration, set the Gain parameter to the value that you extracted from the expValue array.

**1** In the Outline pane on the left, select the Variable component.



- 2 In the Library pane in the middle, under the MATLAB category, double-click **Evaluate MATLAB Expression**. This component is added as a sibling of the Variable component.

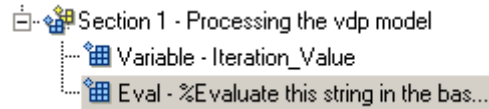

- 3 In the Properties pane on the right, clear the **Insert MATLAB expression in report** and **Display command window output in report** check boxes.
- 4 In the **Expression to evaluate in the base workspace** text box, replace the existing text with the following text.

```
set_param(expBlock,expParam,Iteration_Value);  
okSetValue=(1);
```

The `set_param` command sets the value of the Gain parameter for the Mu block in the vdp model to the value of `Iteration_Value`.

- 5 Make sure you select **Evaluate expression if there is an error**. Enter the following text into the text box:

```
okSetValue=logical(0);
```

If the `set_param` command works, `okSetValue` is set to 1. If an error occurs, `okSetValue` is set to 0. The next component then reports the error and terminates processing.

- 6 Save the report setup file.

The Outline pane on the left looks as follows.

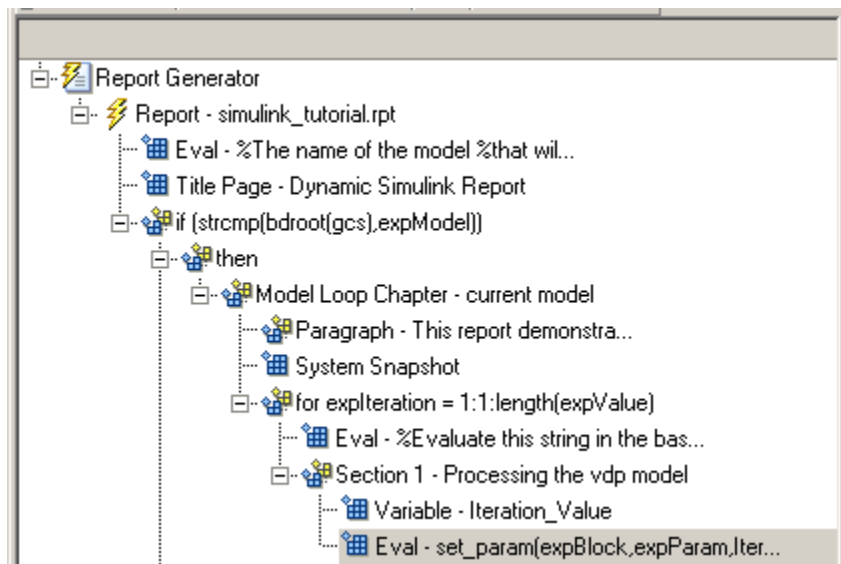

## Check Value Using a Logical If Component

**Note** This section builds on the step-by-step tutorial presented in “Create a Simulink® Report Generator™ Report” on page 3-2.

To see the completed report setup file, open Simulink Dynamic Report. The report is for the vdp model.

Check the value of `okSetValue` using a Logical If component. If the value is 0, the simulation cannot proceed because the Gain parameter could not be set.

- 1 In the Outline pane on the left, select the Eval component for the `set_param` command.
- 2 In the Library pane in the middle, under the Logical and Flow Control category, double-click Logical If. The component is added as a sibling of Eval.

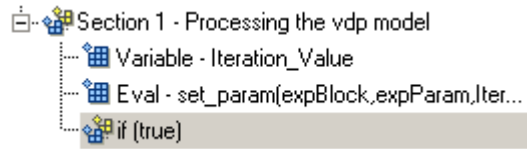

- 3** In the Properties pane on the right, in the **Test expression** text box, replace `true` with `okSetValue`.

`okSetValue` can be 1 (`true`) or 0 (`false`), so insert two components — `Logical Then` and `Logical Else` — to process those conditions:

- 1** In the Outline pane on the left, select the `if(okSetValue)` component.
- 2** To insert `Logical Then` and `Logical Else` in the correct order:
  - a** In the Library pane in the middle, double-click the `Logical Else` component.
  - b** Select the `if(okSetValue)` component again.
  - c** Double-click the `Logical Then` component. The Outline pane on the left looks as follows.

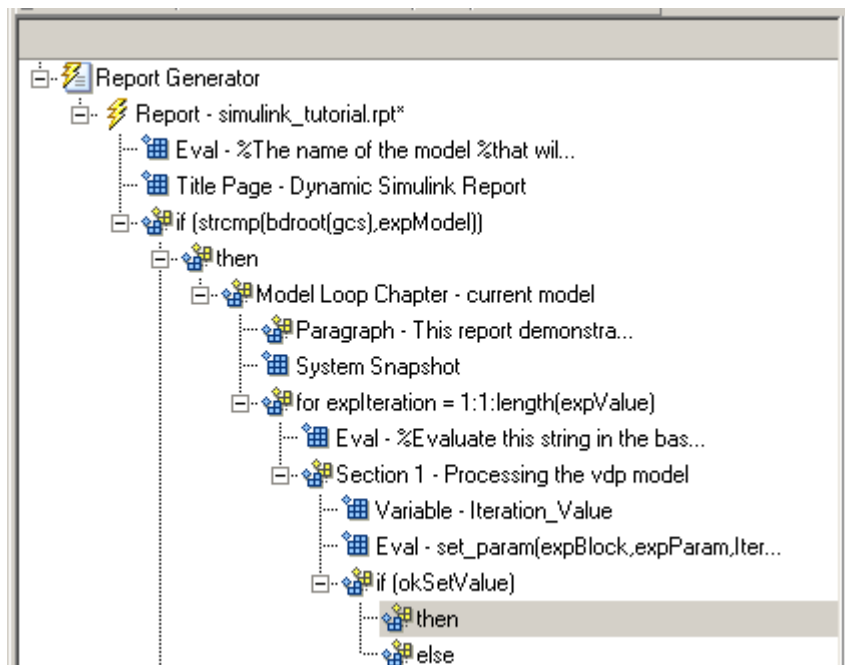

**3** In the Outline pane on the right, select the else component.

**4** In the Library pane in the middle, double-click Paragraph.

If `okSetValue = 0`, the Gain parameter value is not set and the report displays an error.

**5** In the Properties pane on the right:

- a** Choose `Custom` title from the **Title Options** selection list.
- b** Enter `Error` in the text box next to the selection list.
- c** Enter the following text into the **Paragraph Text** text box:

```
Could not set %<expBlock> "%<expParam>" to value  
%<Iteration_Value>.
```

**6** Save the report.

## Simulate the Model Using a Model Simulation Component

---

**Note** This section builds on the step-by-step tutorial presented in “Create a Simulink® Report Generator™ Report” on page 3-2.

To see the completed report setup file, open Simulink Dynamic Report. The report is for the vdp model.

---

Now that the model is open and the Gain parameter is set, use the Model Simulation component to simulate the vdp model.

- 1** In the Outline pane on the left, select the then component under the if (okSetValue) component.
- 2** In the Library pane, under the Simulink category, double-click Model Simulation. In the Outline pane on the left, this component is renamed Simulate model.

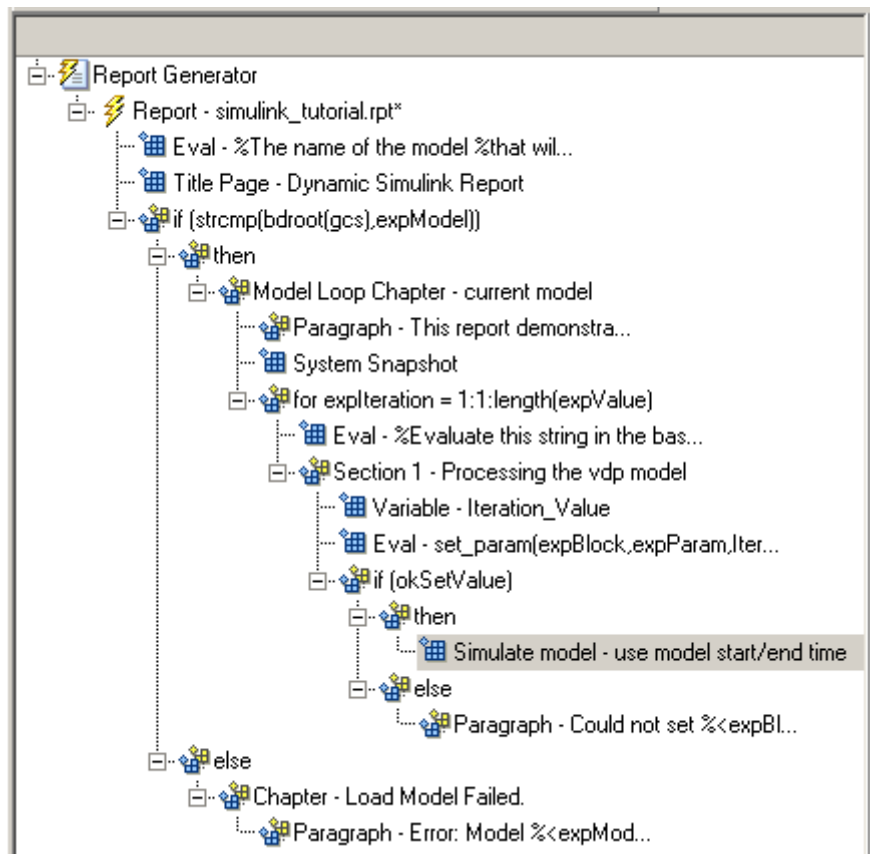

- 3** In the Properties pane on the right:
- a** Clear the **Use model's workspace I/O variable names** check box.
  - b** In the **Time** text box, enter `dynamicT`.
  - c** In the **States** text box, enter `dynamicX`.
  - d** In the **Output** text box, enter `dynamicY`.
- The Properties pane on the right looks as follows.

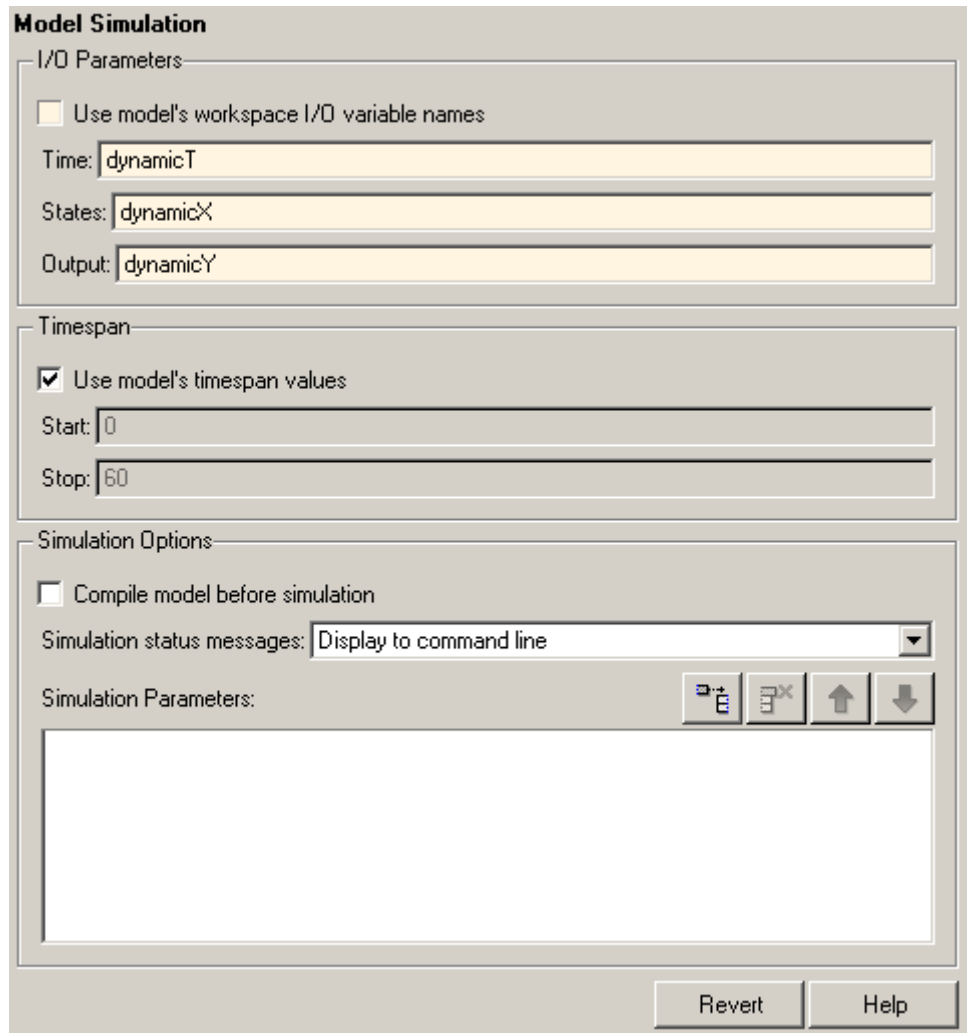

- 4** In the Outline pane on the left, select the `Simulate` model component.
- 5** In the Library pane in the middle:
  - a** Scroll down to the `Simulink Blocks` category.
  - b** Double-click `Scope Snapshot` to add it as a sibling of the `Simulink Model` component.

This component captures the scope for each iteration.

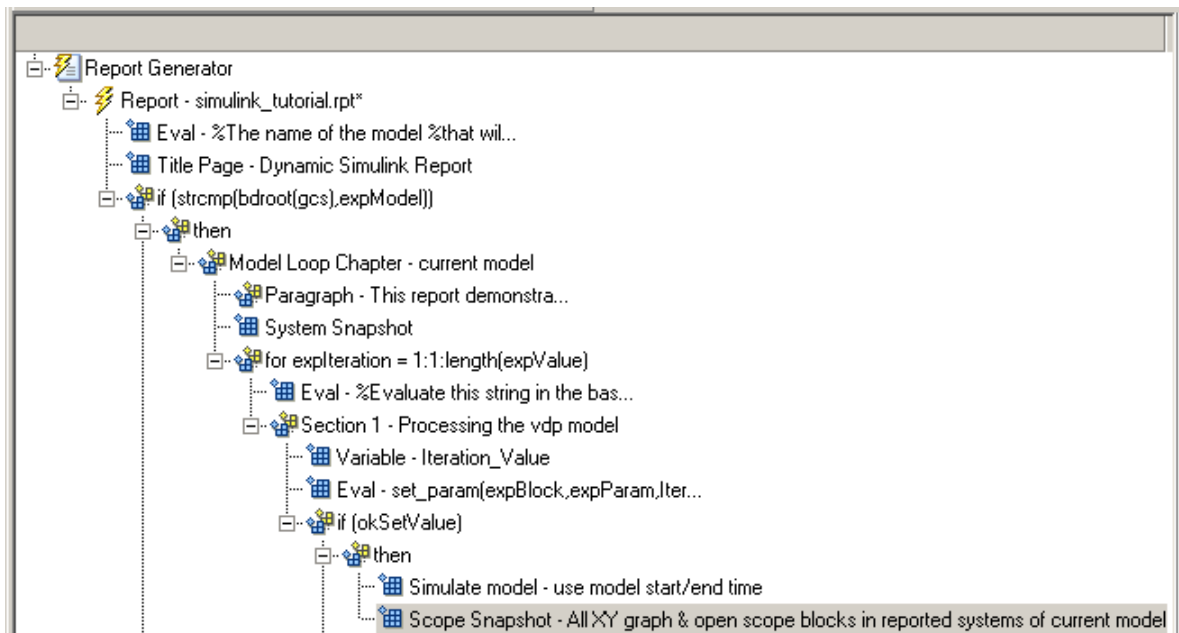

- 6 In the Properties pane on the right:
  - a In the **Paper orientation** selection list, select Portrait.
  - b For the **Image size**, enter [5 4].
  - c In the **Scaling** selection list, select Zoom.
  - d Enter 75 for the % value.
- 7 Save the report setup file.
- 8 To test to see if the signal data falls within a specified range, add another Logical If component:
  - a In the Outline pane on the left, select the Scope Snapshot component.
  - b In the Library pane in the middle, scroll up to the Logical and Flow Control category.
  - c Double-click the Logical If component.



- 9 To test the signal data, replace `true` in the **Test expression** text box with the following in the Properties pane on the right:

```
max(dynamicX(:,2))>testMin & max(dynamicX(:,2))
```

- 10 Save the report.

The Outline pane looks as follows:

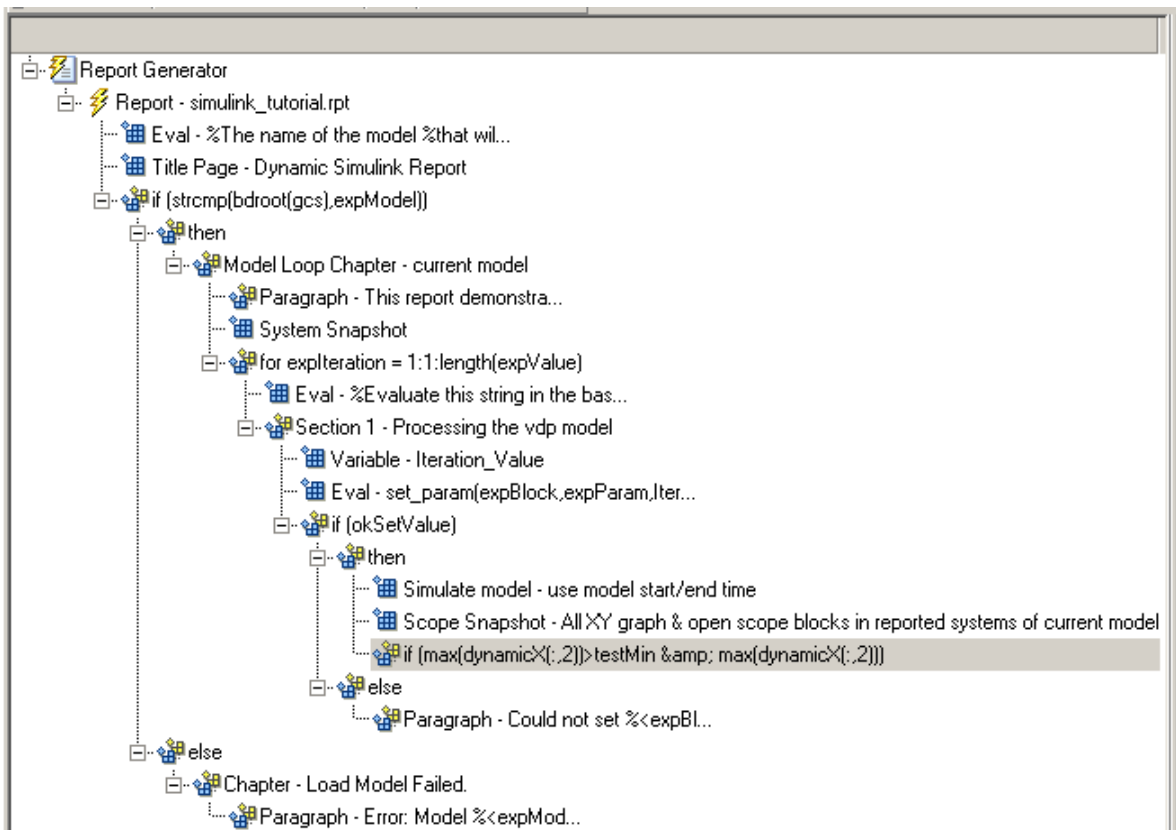

- 11 If this condition is true, the signal data falls within the desired range. Add a Paragraph component to print information about the signal data in the report.

- In the Outline pane on the left, select the `if` component you just added.

- b** In the Library pane in the middle, under the Formatting category, double-click Paragraph so that it becomes a child of the if component.

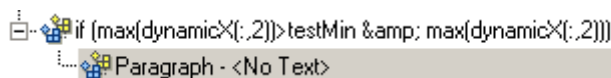

- c** In the Properties pane on the right:
  - i** From the **Title Options** selection list, select Custom title.
  - ii** Type Success in the text box.
  - iii** Enter the following text in the **Paragraph text** text box.

The conditioned signal has a maximum value of `%<max(dynamicX(:,2))>`, which lies in the desired range of greater than `%<testMin>` and less than `%<testMax>`.

- 12** To save the success values to insert into a table at the end of the iterations, use an Evaluate MATLAB Expression component.

- a** In the Outline pane on the left, select the Paragraph component.
- b** In the Library pane in the middle, under the MATLAB category, double-click Evaluate MATLAB Expression.

An unintended result occurs: the new component is a child of the Paragraph component.

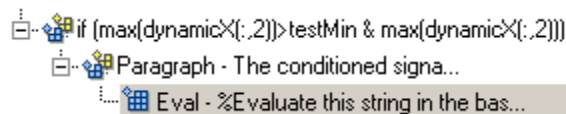

- c** To make the new component a *sibling* of the Paragraph component, in the Outline pane on the left, select the Eval component, and then Click the left arrow on the toolbar. The Eval component becomes a sibling of the Paragraph component.

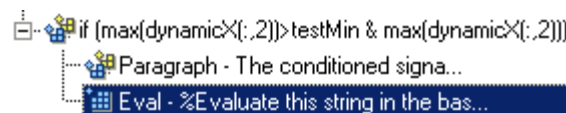

- 13** In the Properties pane on the right, for the Eval component:
- a** Clear the **Insert MATLAB expression in report** and **Display command window output in report** check boxes.
  - b** In the **Expression to evaluate in the base workspace** text box, enter the following to save the desired signal values in the expOkValues array:

```
expOkValues=[expOkValues;...  
             {Iteration_Value,max(dynamicX(:,2))}];
```

- c** Make sure you select **Evaluate this expression if there is an error**. Insert the following text in the text box:

```
disp(['Error during eval: ', evalException.message])
```

- 14** Save the report setup file.

## Create a Post-Test Analysis Section

---

**Note** This section builds on the step-by-step tutorial presented in “Create a Simulink® Report Generator™ Report” on page 3-2.

To see the completed report setup file, open Simulink Dynamic Report. The report is for the vdp model.

---

Now that you have collected all the desired values, create the post-test analysis section by creating a table and inserting it into your report at the end of this chapter.

- 1** In the Outline pane on the left, select the Model Loop Chapter component.

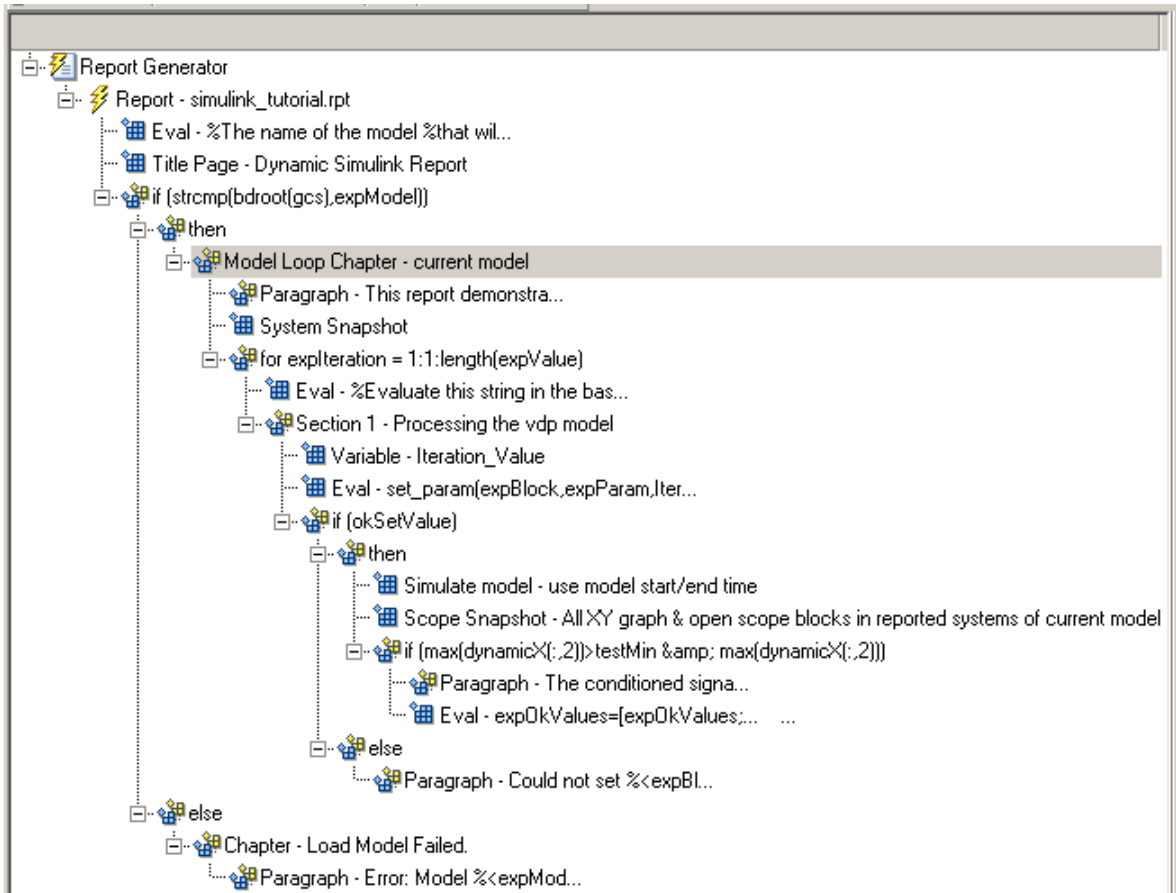

**2** In the Library pane in the middle, under the Formatting category, double-click Chapter/Subsection.

The new section appears at the beginning of the chapter.



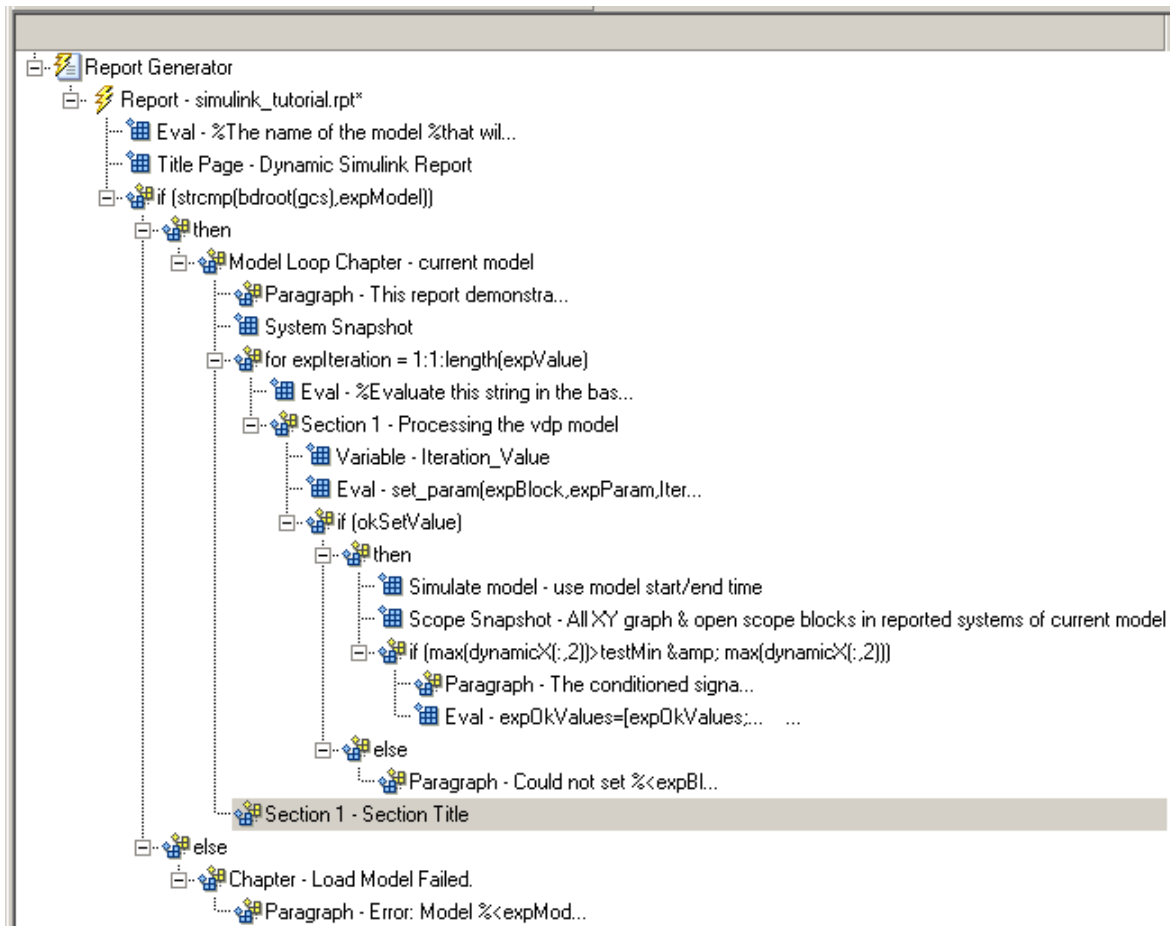

**3** In the Properties pane on the right:

- a** Select Custom in the **Title** selection list.
- b** Enter Post-Test Analysis in the text box.

**4** In the Outline pane on the left, select the new Section 1 component.

**5** In the Library pane in the middle, under the Formatting category, double-click Paragraph. Do not change its properties.

**6** To check whether there are any signal values within the desired range, check the array `expOkValues` with a **Logical If** component. If `expOkValues` is empty, there are no signal values in the desired range. Report the result of this check.

**a** In the Outline pane on the left, select the **Paragraph** component and add a **Logical If** child component.

**b** In the Properties pane on the right, enter the expression to evaluate in the **Test expression** text box:

```
~isempty(expOkValues)
```

This expression evaluates to 0 (false) if `expOkValues` is empty; otherwise, it evaluates to 1 (true).

**c** In the Outline pane on the left, select the `if (~isempty(expOkValue))` component and add the **Logical Else** component as a child.

**d** Select the `if (~isempty(expOkValue))` component again and add the **Logical Then** component as a child.

The two components are siblings in the Outline pane on the left.

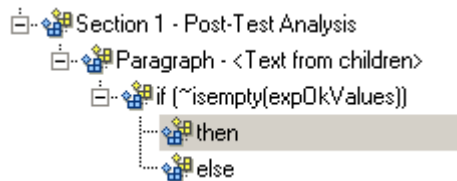

**7** Save the report setup file.

**8** Now, insert report components to handle the case where `expOkValues` is empty; that is, where no signal values fall within the designated range.

**a** In the Outline pane on the left, select the **else** component.

**b** In the Library pane in the middle, double-click the **Text** component to add it as a child of the **else** component.

**c** In the Properties pane on the right, in the **Text to include in report** text box, enter the following:

```
None of the selected iteration values had
```

a maximum signal value between %<testMin> and %<testMax>.

- 9 Now handle the case where `expOkValues` is not empty and you want to insert a table of the acceptable signal values.
  - a In the Outline pane on the left, select the `then` component.
  - b Add a Text component as a child to the `then` component.
  - c In the Properties pane on the right, in the **Text to include in report** text box, enter the following text.

```
%<size(expOkValues, 1)> values for %<expBlock> were
found that resulted in a maximum signal value greater
than %<testMin> but less than %<testMax>. The following
table shows those values and their resulting signal maximum.
```

- d In the Outline pane on the left, select the Text component under the `then` component of the `if(~isempty(expOkValues))` component.
- 10 To create an array for use when formatting the table, use the Evaluate MATLAB Expression component.
  - a In the Library pane in the middle, double-click Evaluate MATLAB Expression.
  - b In the Properties pane on the right:
    - i Clear the **Insert MATLAB expression in report** and **Display command window output in report** check boxes.
    - ii The next component of the report uses the strings `Mu Value` and `Signal Maximum` as table header values. Add the strings to the front of the `expOkValues` cell array by entering the following text into the **Expression to evaluate in the base workspace** text box:

```
expOkValues={['Mu Value', 'Signal Maximum'} expOkValues];
```
    - iii Make sure you select the **Evaluate this expression if there is an error** check box. Enter the following text into the text box:

```
disp(['Error during eval: ', evalExpression.message])
```



- 11 In the Outline pane on the left, select the Eval component.
- 12 In the Library pane in the middle, under the Formatting category, double-click the Table component so it becomes a sibling of the Text and Eval components.

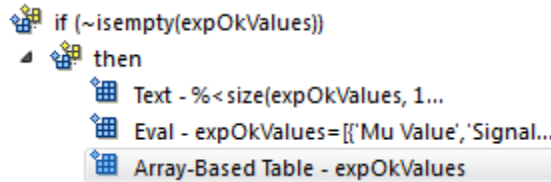

- 13 In the Properties pane on the right:
  - a In the **Workspace variable name** text box, enter expOkValues. The Simulink Report Generator software uses the contents of expOkValues to construct the table.
  - b In the **Table title** text box, enter Valid Iteration Values.
- 14 Save the report setup file.

The Outline pane on the left looks as follows.

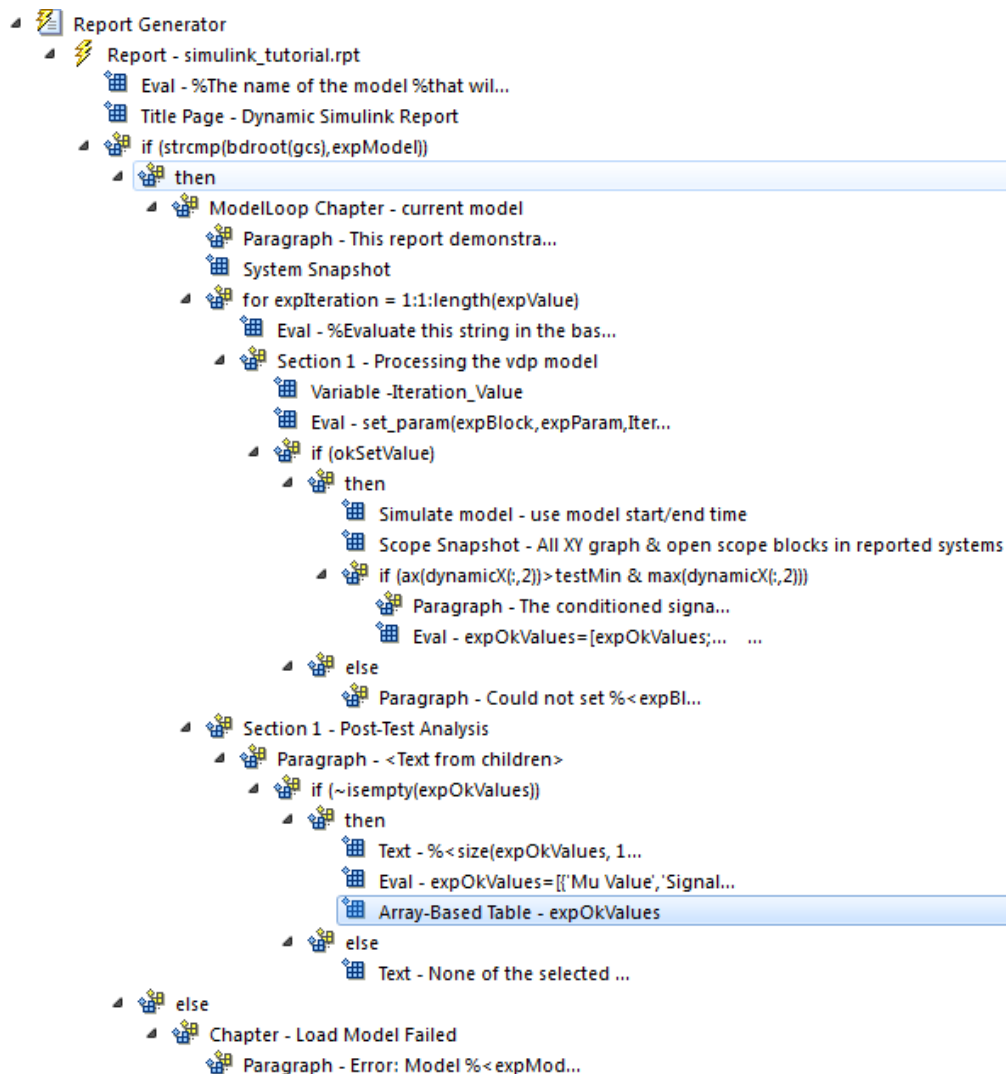

## Error Handling for MATLAB Code

You can add MATLAB code to a report, by using the Evaluate MATLAB Expression component (also called the Eval component). See “Add MATLAB Code” on page 3-7 for details.

The Evaluate MATLAB Expression component dialog box includes an **Evaluate this expression if there is an error** check box. The dialog box includes default error handling code that you can use, or you can create your own error handling code.

If you do not change the default error handling code, then when you generate the report, and there is an error in the MATLAB code that you added:

- If you clear **Evaluate this expression if there is an error** check box, then the complete report is generated, without displaying an error message at the MATLAB command line.
- If you select **Evaluate this expression if there is an error** check box, then the complete report is generated and an error message appears at the MATLAB command line.

To stop report generation when an error occurs in the MATLAB code that you added, change the second and third lines of the following default error handling code, as described below:

```
warningMessageLevel = 2;  
displayWarningMessage = true;  
failGenerationWithException = false;  
failGenerationWithoutException = false;
```

To stop report generation and display an exception, change the default code to:

```
displayWarningMessage = false;  
failGenerationWithException = true;
```

To stop report generation without displaying an exception, change the default code to:

```
displayWarningMessage = false;  
failGenerationWithoutException = true;
```

If you want to completely replace the default error handling code, use the `evalException.message` variable in your code to return information for the exception.

## Generate the Report

Now the report includes all required components. To generate the report, click the **Report** icon on the toolbar. The following occurs:

- 1 A Message List window appears, displaying informational and error messages as the report is processed. Specify the level of detail you would like the Message List window to display while the report is being generated. Options range from 0 (least detail) to 6 (most detail). Click the selection list located under the title bar of the Message List window to choose an option, as shown in the following figure.

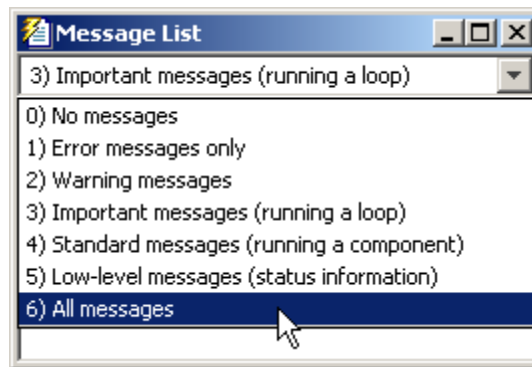

Message level 3 (Important messages) is used for the remainder of this example.

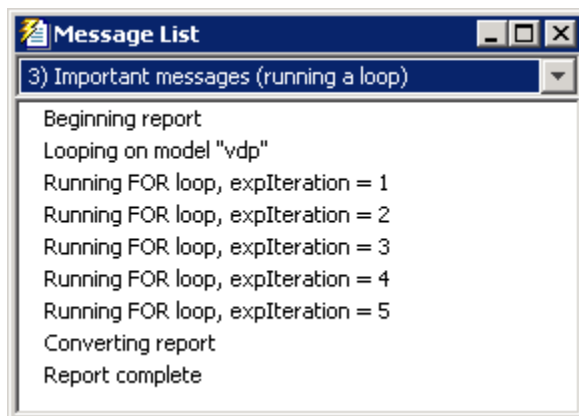

- 2** The vdp model appears. You can see each time it is simulated.
- 3** The scope window appears. The scope graph changes each time the parameter value changes.
- 4** Each component of the report is highlighted as it executes, in the Outline pane on the left in the Report Explorer window.

When the report is complete, Adobe Acrobat Reader opens your report in PDF format.

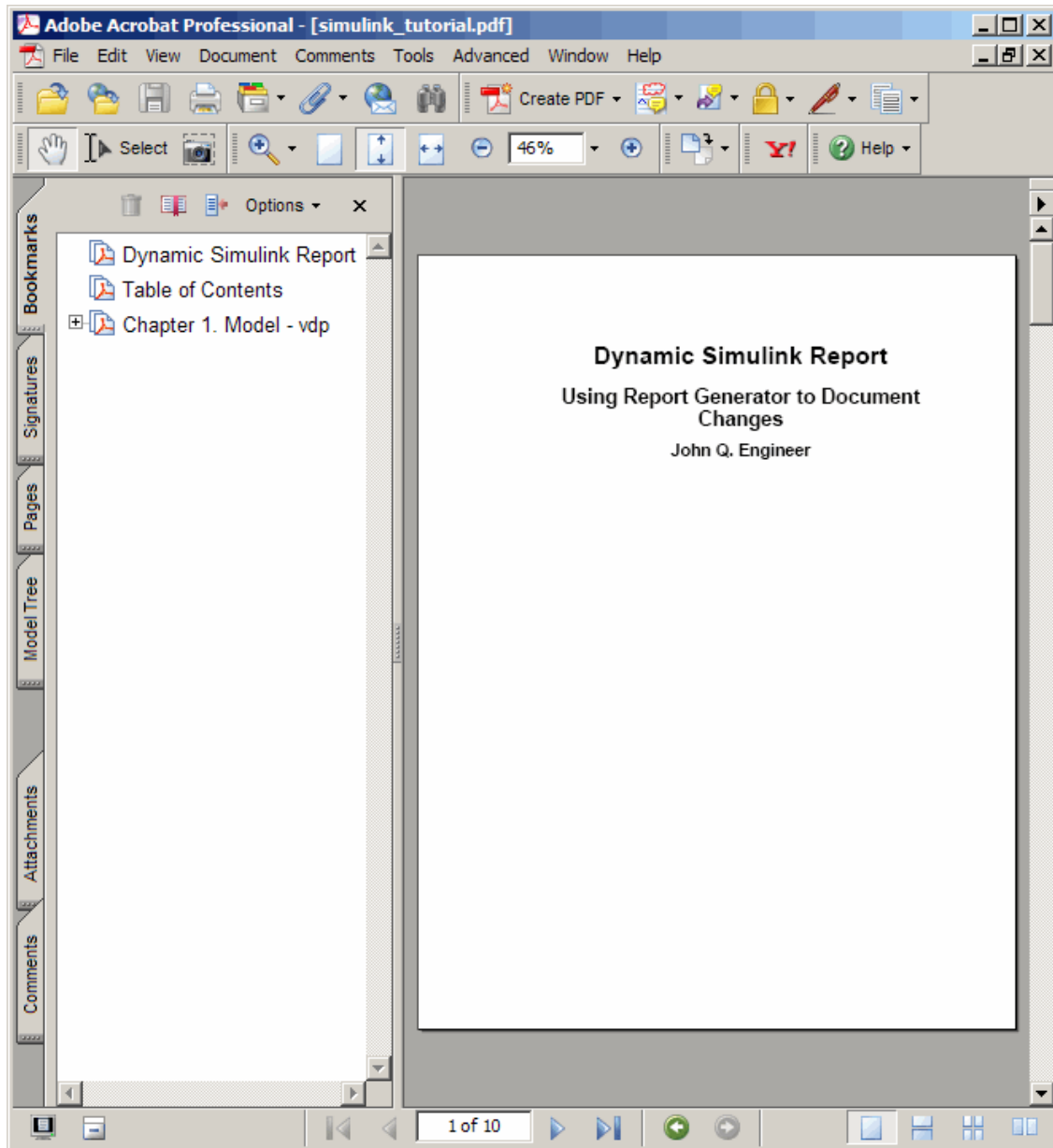





# Generate a Report

---

- “Generate a Report” on page 4-2
- “Set Report Output Options” on page 4-4
- “Change Report Locale” on page 4-15
- “Convert XML Documents” on page 4-16
- “Create a Log File” on page 4-19
- “Generate MATLAB Code from Report Setup File” on page 4-20
- “Legacy Report Setup Files” on page 4-23
- “Troubleshooting Report Generation Issues” on page 4-25

# Generate a Report

In this section...
“Run a Report” on page 4-2
“Report Output Options” on page 4-2

## Run a Report

You can generate a Simulink Report Generator report using one of these methods:

- In the Report Explorer Outline pane, select a report and do one of the following actions:
  - In the Report Explorer toolbar, click the Report button (  ).
  - Press **CTL+R**.
  - Select **File > Report**.
- From the MATLAB command line, use the `report` command. For example, to print the `system1_description` report in PDF format, use:

```
report system1_description -fpdf
```

## Report Output Options

Before you generate a report, you can set options to control aspects of report generation processing such as:

- Output file format (PDF, HTML, or Microsoft Word)
- Stylesheet for the selected output file format, to control the layout of the report (for example, whether to display a title page, font, and section numbering)
- Output file location
- Whether to regenerate image files
- Whether to view the generated report automatically

For details, see:

- “Report Output Format and Stylesheet” on page 4-4
- “Output File Location” on page 4-12
- “Regenerate Images” on page 4-13
- “Create a Log File” on page 4-19
- “Add Description of Report Setup” on page 4-14
- “Change Report Locale” on page 4-15

## Set Report Output Options

### In this section...

- “Report Output Format and Stylesheet” on page 4-4
- “PDF Stylesheets” on page 4-7
- “Web Stylesheets” on page 4-8
- “RTF (DSSSL Print) and Word Stylesheets” on page 4-9
- “Report Generation Processing” on page 4-9
- “Output File Location” on page 4-12
- “Regenerate Images” on page 4-13
- “Add Description of Report Setup” on page 4-14

## Report Output Format and Stylesheet

In the Report Explorer, in the Report Options pane, choose the report output format in the **File format** text box. For example, if you want to use Microsoft Word, choose Word document or Rich Text Format.

Report Format and Stylesheet

File format: Rich Text Format Very Large Type Print

Generation Options

View report after generation

Auto save before generation

Evaluate this string after generation:

Each output format has a default stylesheet associated with it. Specify the stylesheet in the text box next to the **File format** text box.

The following table shows which output format to use with different software, and which stylesheets you can use with each output format.

<b>Viewer</b>	<b>Format</b>	<b>Description</b>	<b>Stylesheets</b>
Adobe Acrobat Reader	Adobe Acrobat (PDF)	Produces a PDF that you can view using Adobe Acrobat Reader software	PDF (see “PDF Stylesheets”)
Web browser	Web (HTML) (default)	Use for publishing on the World Wide Web	Web (see “Web Stylesheets”)
Word processor	Rich Text Format (RTF) or Word Document	Compatible with most word-processing packages, including Microsoft Word software	Print (see “RTF (DSSSL Print) and Word Stylesheets”)
DocBook	DocBook (XML)	Produces a report in DocBook format	N/A

---

**Note** For reports that use the Word Document format, you must have Microsoft Word software installed on the machine that you use to generate the report.

---



---

**Tip** To create and use customized styles, see “Create a New Stylesheet”.

---

### **Change the Default Output Format**

In the Report Generator Preferences pane, use the **Format ID** preference to specify the default output format for reports.

## Stylesheets

For each output format, you can choose from several stylesheets for each report output format. For details, see:

- “PDF Stylesheets” on page 4-7
- “Web Stylesheets” on page 4-8
- “RTF (DSSSL Print) and Word Stylesheets” on page 4-9

---

**Note** Some Web and Print stylesheets include an automatically generated list of titles. The list of titles includes a list of table titles and a list of figures with titles.

---

## Image Format

In the Report Generator Preferences pane, use the following preferences to specify the default image file format.

Preference	Purpose
Simulink Images	Specify the format for Simulink images to include in the report. The default is PNG 24-bit image.
Stateflow Images	Specify the format for Stateflow charts to include in the report. The default is PNG 24-bit image.
HG Images	Specify the format for Handle Graphics images to include in the report. The default is PNG 24-bit image.

## PDF Stylesheets

PDF Stylesheet	Description
Default print stylesheet	Displays title page, table of contents, list of titles
Standard Print	Displays title page, table of contents, list of titles
Simple Print	Suppresses title page, table of contents, list of titles
Compact Simple Print	Minimizes page count, suppresses title, table of contents, list of titles
Large Type Print	Uses 12-point font (slightly larger than Standard Print)
Very Large Type Print	Uses 24-point font and landscape paper orientation
Compact Print	Minimizes white space to reduce page count
Unnumbered Chapters & Sections	Chapters and sections are not numbered
Numbered Chapters & Sections	Chapters and sections are both numbered
Paginated Sections	Sections are printed with page breaks
Custom Header	Lets you specify custom headers and footers
Custom Titlepage	Lets you specify custom title page content and presentation
Verbose Print	Lets you specify advanced print options

## Web Stylesheets

Web Stylesheet	Description
Default HTML stylesheet	HTML on a single page
Simulink book HTML stylesheet	HTML on multiple pages; suppresses chapter headings and table of contents
Truth Table HTML stylesheet	HTML on multiple pages; suppresses chapter headings and table of contents
Multi-page Web	HTML, with each chapter on a separate page
Single-page Web	HTML on a single page
Single-page Unnumbered Chapters & Sections	HTML on a single page; chapters and sections are not numbered
Single-page Numbered Chapters & Sections	HTML on a single page; chapters and sections are numbered
Single-page Simple	HTML on a single page; suppresses title page and table of contents
Multi-page Simple	HTML on multiple pages; suppresses title page and table of contents
Multi-page Unnumbered Chapters & Sections	HTML on multiple pages; chapters and sections are not numbered.
Multi-page Numbered Chapters & Sections	HTML on multiple pages; chapters and sections are numbered



## RTF (DSSSL Print) and Word Stylesheets

RTF or Word Stylesheet	Description
Standard Print	Displays title page, table of contents, list of titles
Simple Print	Suppresses title page, table of contents, list of titles
Compact Simple Print	Minimizes page count, suppresses title, table of contents, list of titles
Large Type Print	Uses 12-point font (slightly larger than Standard Print)
Very Large Type Print	Uses 24-point font and landscape paper orientation
Compact Print	Minimizes white space to reduce page count
Unnumbered Chapters & Sections	Chapters and sections are not numbered
Numbered Chapters & Sections	Chapters and sections are both numbered

## Report Generation Processing

### Report Explorer Report Options

In the Report Explorer, in the Report Options pane includes several options for controlling report processing.

<b>Option</b>	<b>Purpose</b>
<b>View report after generation</b>	<p>Select this option to view the report automatically. When report generation is complete, the viewer associated with the report output format displays the report.</p> <p>To view the report manually, browse to the location specified in the <b>Report File Location</b> section in the Properties pane on the right, and open the file.</p>
<b>Auto save before generation</b>	<p>To automatically save the report setup file before you generate a report, select <b>Auto save before generation</b>.</p>
<b>Compile model to report on compiled information</b>	<p>By default, the Simulink Report Generator reports uncompiled values of Simulink parameters. The uncompiled values of some parameters, such as signal data types, can differ from the compiled values used during simulation. To ensure that a report reflects compiled values, select the <b>Compile model to report on compiled information</b> option. This option causes the report generator to compile a model before reporting on model parameters. After generating the report, the report generator returns the model to its uncompiled state.</p>

Option	Purpose
	<p><b>Note</b> When you select this option, whenever report generation requires simulating the model (for example, the report includes a Model Simulation component), the report generator uncompiles the model and then recompiles the model, if necessary, to report on model contents. If a report requires multiple compilations, the processing can be quite time-consuming.</p> <p>To minimize compilations, consider using separate reports to report on the contents of a model and on the results of simulating that model.</p>
<b>Evaluate this string after generation</b>	Specify MATLAB code for processing to occur after the report is generated. For example, you could specify to close a model.

## Report Processing Preferences

The Report Generator Preferences pane provides several preferences to control report processing.

Preference	Purpose
View command	Specify the MATLAB command you want to use to view the report.
Visible in Report Explorer	Deselect this check box to make the current output format unavailable in the Report Explorer interface. For example, if your specified report format is Word document and you deselect this check box, then the Microsoft Word document format is no longer available for reports created using the Report Explorer.

Preference	Purpose
Use version 1.x environment	Choose this option to use previous versions of MATLAB Report Generator and Simulink Report Generator interfaces. For more information, see “Use Legacy Interface” on page 4-24.
Animate Report Explorer when generating reports	Select this check box if you want components in the Outline pane to be animated as the report generates. This box is selected by default.

## Output File Location

Choose a folder to which you have write privileges, to store the report file. A list of options appears in the following table.

## Report File Location

In the Report Explorer, in the Report Options pane, use the **Directory** field to specify the name of the folder in which to store the generated report file. Specify a folder to which you have write privileges.

The following table summarizes the report file location options.

Folder	Option
The same folder as the report setup file	Same as setup file
The current working folder	Present working directory
Temporary folder	Temporary directory
Another folder	Custom. Use the <b>Browse</b> button (...) to select from a list of directories.

You can use %<VariableName> notation to specify a folder in the **Custom** text box. For more information, see “% Notation” on the Text component reference page in the MATLAB Report Generator documentation.

## Report File Name

In the Report Explorer, in the Report Options pane, use the **Filename** field to specify a file name for the report file. Select one of the options listed in the following table.

File Name	Option
The same file name as the report setup file	Same as setup file (default)
A file name different from the report setup file name	Custom. Enter the name of the report.

Use %<VariableName> notation to specify a file name in the **Custom** text box. For more information, see “% Notation” on the Text component reference page in the MATLAB Report Generator documentation.

## Report File Extension

By default, the report file extension reflects the output format for the report. For example, if you specify Web (HTML) output, the default extension for the report file is .html.

To change the default extension, in the Report Generator Preferences pane, select a **Format ID** and in the **Extension** preference, specify an extension.

## Image Output File Location

Images are placed in a folder with the same name as the report file. For example, testreport.html images are placed in a folder named testreport\_files.

## Regenerate Images

By default, the **Regenerate Simulink and Stateflow Images** option in the **Generation Options** section of the Properties pane on the right is cleared. As a result, previously generated images are not regenerated each time you generate a report, so reports generate faster. If you make changes that affect a generated image, select this option.

### **Add Description of Report Setup**

Use the **Report Description** field in the Properties pane on the right to record notes and comments about your report setup. This text appears in the Properties pane on the right when you select a report setup file in the Outline pane on the left.

## Change Report Locale

Versions 2.0 and later of the MATLAB Report Generator and Simulink Report Generator software use the locale (system language settings) through the Sun™ Java™ interface; therefore, they should use the language specified on your system.

Alternatively, you can change the language directly in Java from the MATLAB command line. The following example sets the language to Italian:

```
java.util.Locale.setDefault(java.util.Locale.ITALY)
```

Alternatively, you can set the preferred language directly in your `.rpt` file:

- 1 Right-click the **Report** component and select **Send to Workspace**.

This displays the properties of the report, which are stored in the variable `ans`. Access the report's `Language` property from the command line through this variable. By default, `Language` is `auto`, which indicates that the system's default language is in use.

- 2 Override the default value of `Language` by setting this property to your desired language; for example, `en` for English or `it` for Italian.

## Convert XML Documents

In this section...
“Why Convert XML Documents?” on page 4-16
“Convert XML Documents Using the Report Explorer” on page 4-16
“Convert XML Documents Using the Command Line” on page 4-18
“Edit XML Source Files” on page 4-18

### Why Convert XML Documents?

You can generate a report in a different output file format without regenerating it by using either the Report Explorer File Converter or the `rptconvert` command. These utilities convert DocBook XML source files created by the report-generation process into formatted documents such as HTML, RTF, or PDF.

---

**Note** The report-generation process can only convert XML source files created by the latest version of the software.

---

### Convert XML Documents Using the Report Explorer

To open the **Convert** Properties pane:

- 1 In the Report Explorer, select **Tools > Convert source file**.

The Convert Source File Properties pane appears. All XML files in your current folder appear in the Options pane in the middle.



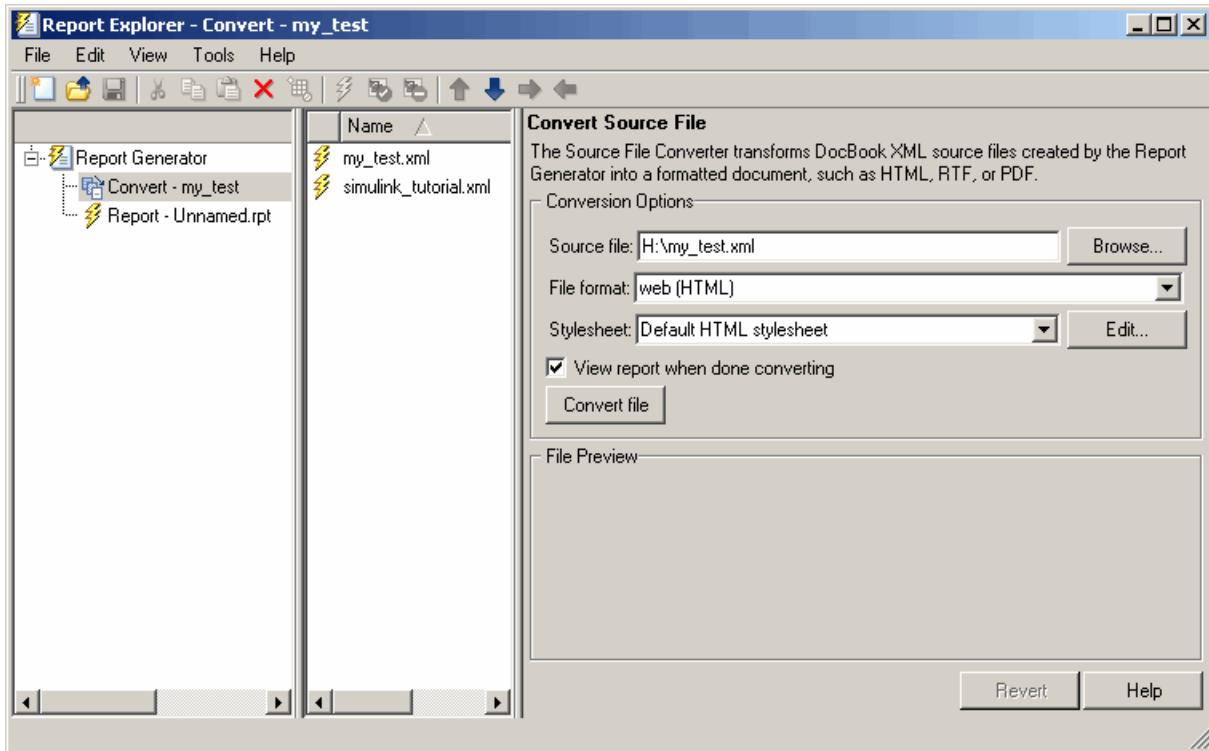

- 2 Select your XML source file using one of the following options:
  - Click **Browse** in the Properties pane on the right to browse to the location of your XML source.
  - Double-click a file name in the Options pane in the middle to automatically enter it into the **Source file** field in the Properties pane.
- 3 Select your output format and stylesheet:
  - a In the **File format** text box, select an output format.
  - b In the **Stylesheet** text box, select a stylesheet. The stylesheet choice depends on the specified output format. You can use a predefined or customized stylesheet.

For more information about available formats and predefined stylesheets, see “Report Output Format and Stylesheet”.

For more information about customizing stylesheets, see “Create a New Stylesheet”.

- 4 Use the **View Report when done converting** check box to indicate whether you want to view the report after it has conversion.
- 5 To begin the conversion, click **Convert file**.

### **Convert XML Documents Using the Command Line**

To convert files using the command line, use the `rptconvert` function.

### **Edit XML Source Files**

Before you send a source file to the converter, edit it as text in the Report Explorer:

- 1 In the Outline pane on the left, open the File Converter.
- 2 Right-click **MATLAB Report Generator** and select **Convert source file**.
- 3 In the Options pane in the middle, select the source file to edit.
- 4 In the Properties pane on the right, click **Edit as text**.
- 5 Use the MATLAB Editor to edit and save the text.

## Create a Log File

A log file describes the report setup file report-generation settings and components. A log file can be used for many purposes, including:

- As a debugging tool
- As a reference to a report setup file
- To share information about a report setup file through email

A log file includes the following information:

- Report setup file outline
- Components and their attributes
- Generation status messages currently displayed in the **Generation Status** tab

To generate a log file, click **File > Log File**. An HTML version of the log file with the name <report\_template\_file\_name\_log>.html is saved in the same folder as the report setup file.

## Generate MATLAB Code from Report Setup File

You can generate MATLAB code versions of report setup files in the form of a MATLAB file (\*.m). A MATLAB file of a report setup file is useful for various purposes, including generating reports and modifying report setup files programmatically.

To generate a MATLAB file, load a report setup file into the Report Explorer and click **File > Generate MATLAB File**. After the MATLAB file generates, it opens in the MATLAB Editor. The filename for the generated file is the file name of the report setup file, preceded by “build.”

### Generate Reports from MATLAB Files

This example generates a MATLAB file from the `figloop_tutorial.rpt` report setup file, which is part of the MATLAB Report Generator software. The example then uses the `report` function to generate a report from the MATLAB file. For more information about this function, see the `report` reference page.

- 1** Start the Report Explorer by entering `report` in the MATLAB Command Window.
- 2** In the Options pane in the middle, double-click `figloop_tutorial.rpt` to open its report setup file.
- 3** In the Outline pane on the left, click `Report - figloop_tutorial.rpt` to select it.
- 4** In the Report Explorer menu bar, click **File > Generate MATLAB File**.

The MATLAB Report Generator software generates MATLAB code for the `figloop_tutorial.rpt` report setup file. It saves this code in the `buildfigloop_tutorial.m` file in the folder you specify. Part of this file appears in the following figure.

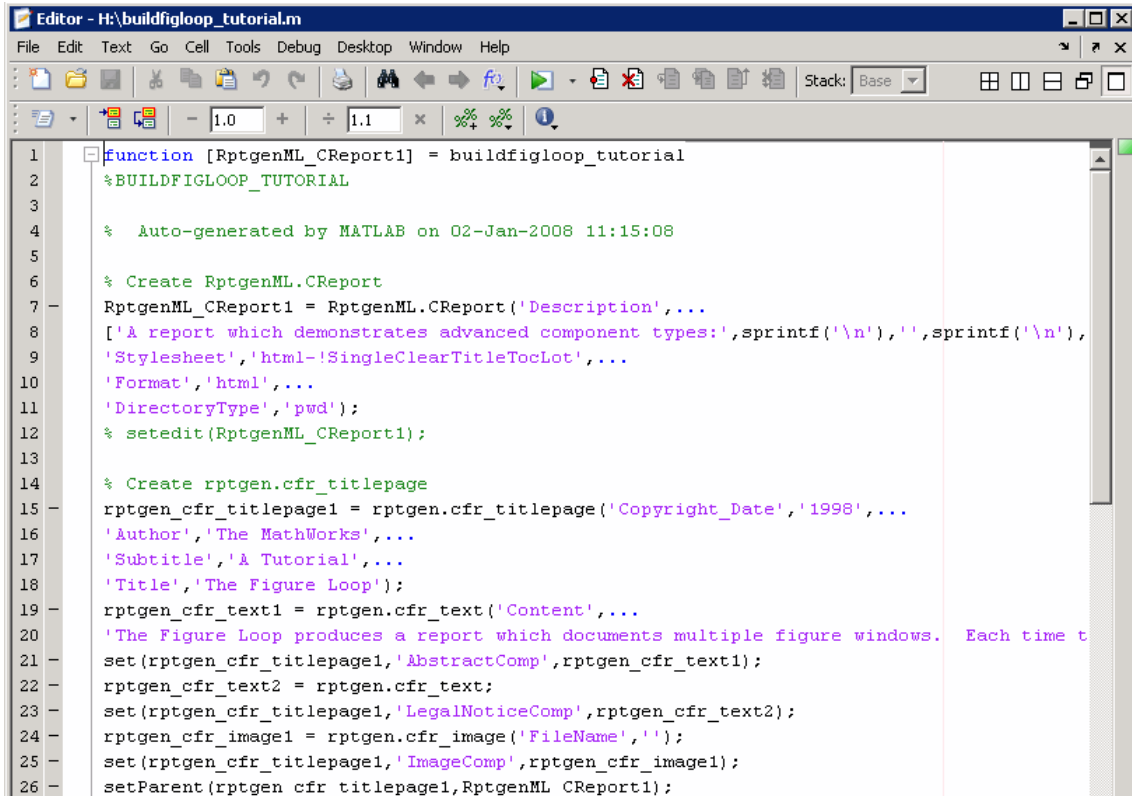

```

1  function [RptgenML_CReport1] = buildfigloop_tutorial
2     %BUILDFIGLOOP_TUTORIAL
3
4     % Auto-generated by MATLAB on 02-Jan-2008 11:15:08
5
6     % Create RptgenML.CReport
7     RptgenML_CReport1 = RptgenML.CReport('Description',...
8     ['A report which demonstrates advanced component types:',sprintf('\n'),' ',sprintf('\n'),
9     'Stylesheet','html-!SingleClearTitleTocLot',...
10    'Format','html',...
11    'DirectoryType','pwd');
12    % setedit(RptgenML_CReport1);
13
14    % Create rptgen.cfr_titlepage
15    rptgen_cfr_titlepage1 = rptgen.cfr_titlepage('Copyright_Date','1998',...
16    'Author','The MathWorks',...
17    'Subtitle','A Tutorial',...
18    'Title','The Figure Loop');
19    rptgen_cfr_text1 = rptgen.cfr_text('Content',...
20    'The Figure Loop produces a report which documents multiple figure windows. Each time t
21    set(rptgen_cfr_titlepage1,'AbstractComp',rptgen_cfr_text1);
22    rptgen_cfr_text2 = rptgen.cfr_text;
23    set(rptgen_cfr_titlepage1,'LegalNoticeComp',rptgen_cfr_text2);
24    rptgen_cfr_image1 = rptgen.cfr_image('FileName','');
25    set(rptgen_cfr_titlepage1,'ImageComp',rptgen_cfr_image1);
26    setParent(rptgen_cfr_titlepage1,RptgenML_CReport1);

```

- 5** To generate the figloop\_tutorial report from this MATLAB file, run the following command in the MATLAB Command Window:

```
report(buildfigloop_tutorial);
```

The MATLAB Report Generator software runs and displays the report.

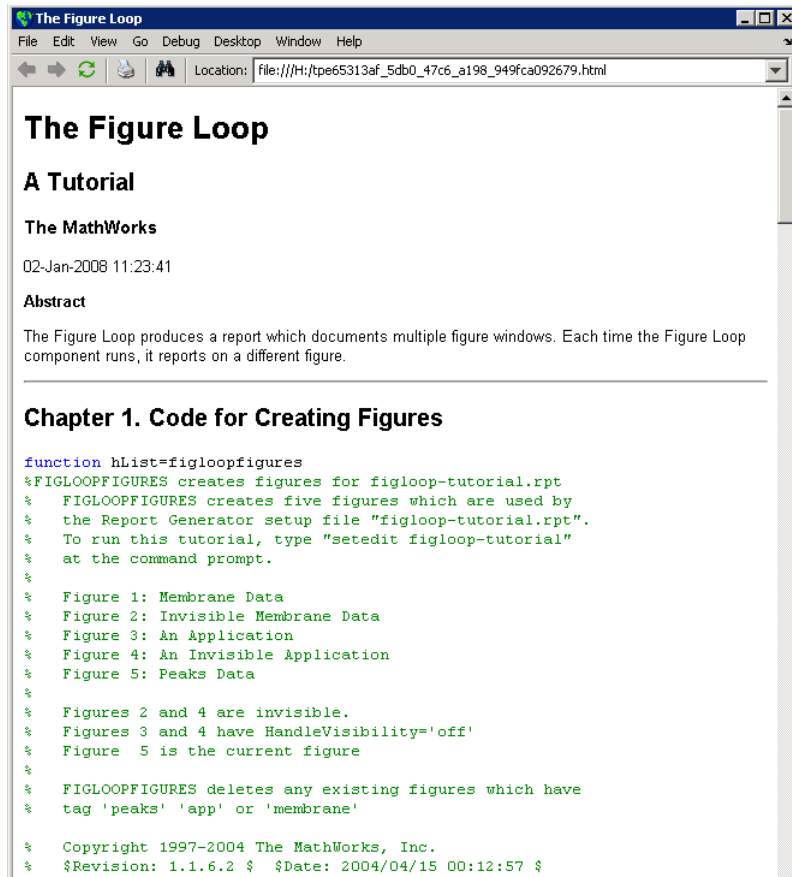

## Legacy Report Setup Files

### In this section...

“What Are Legacy Report Setup Files?” on page 4-23

“Enable Legacy Interface” on page 4-23

“Use Legacy Interface” on page 4-24

### What Are Legacy Report Setup Files?

Legacy report setup files are files that you created in previous versions of the MATLAB Report Generator or Simulink Report Generator software. You can load legacy report setup files in the current version of the Report Explorer. Alternatively, you can use earlier versions of the product interfaces to work with legacy report setup files.

### Enable Legacy Interface

Enable the previous versions of the interfaces at the MATLAB command line:

```
RptgenML.v1mode(true)
```

The result is:

```
ans =
```

```
1
```

A logical 1 indicates that Version 1 mode is on. To turn off Version 1 mode, enter:

```
RptgenML.v1mode(false)
```

The result is:

```
ans =
```

```
0
```

A logical 0 indicates that Version 1 mode is off.

### Use Legacy Interface

When you enable Version 1 mode, you can use previous versions of MATLAB Report Generator or Simulink Report Generator interfaces.

When using earlier versions of these interfaces, the following restrictions apply:

- You cannot use a report setup file created in the latest version of the MATLAB Report Generator or Simulink Report Generator software with earlier interfaces. If you save a legacy report setup file in the latest version of the software, you can no longer work with the same report setup file in the old interface.
- You cannot use the old interfaces with the latest version of the MATLAB Report Generator or Simulink Report Generator software. The Report Template Editor can coexist with the Report Explorer, but MathWorks does not recommend using these interfaces together.



## Troubleshooting Report Generation Issues

In this section...
“Memory Usage” on page 4-25
“HTML Report Display on UNIX Systems” on page 4-25

### Memory Usage

By default, the MATLAB software sets a limit of 100 MB on the amount of memory the Sun Java Virtual Machine (JVM™) software can allocate. The memory that the report generation process uses to build a document must fit within this limit. If you are having trouble processing large reports, it might be helpful to increase the amount of memory that MATLAB Report Generator and Simulink Report Generator software can allocate. See the following sections for more information.

### Run the MATLAB Software Without a Desktop

One way to increase the amount of JVM memory available to the MATLAB Report Generator and Simulink Report Generator software is to run the MATLAB software with `-nodesktop` mode enabled.

---

**Note** This option is available on UNIX® platforms only. (UNIX is a registered trademark of The Open Group in the United States and other countries.)

---

### Increase the MATLAB JVM Memory Allocation Limit

To increase the amount of JVM memory available by increasing the MATLAB JVM memory allocation limit, from the MATLAB Toolstrip, in the **Home** tab, in the **Environment** section, select **Preferences**. Use the **General > Java Heap Memory** dialog box.

### HTML Report Display on UNIX Systems

HTML reports may not automatically display on some UNIX platforms. To work around this issue, configure the MATLAB Report Generator software to launch an external browser:

- 1 In the Report Explorer, click **File > Preferences**.
- 2 Enter the following text in the **View command** field:  

```
web(rptgen.file2urn('%file name'), '-browser')
```

Where *file name* is the name of your report setup file.

# Export Simulink Models to Web Views

---

- “Web Views” on page 5-2
- “Export Models to the Web” on page 5-3
- “Navigate Web Views” on page 5-7
- “Create Web Views of Simulink Models” on page 5-11
- “Troubleshooting Web Views” on page 5-21

# Web Views

A Web view is an interactive rendition of a model that you can view in a Web browser. You can use Web views to navigate hierarchically to specific subsystems and see properties of blocks, signals, and scopes. You can zoom in and out, pan, and fit your model to your view using the same keyboard shortcuts that you use in Simulink and Stateflow editors.

You need the Simulink Report Generator software to create Web views. Web views require that your Web browser support Adobe SVG, implemented natively or through a plug-in. You do not have to install MathWorks products to use Web views. Therefore, Web views are useful for presenting models to audiences and for sharing models with colleagues who do not have MathWorks products installed. The MATLAB Web browser does not support Web views.

## Export Models to the Web

In this section...
“Open the Export Interface” on page 5-3
“Set Export Options” on page 5-3
“Generate and Review Web Views” on page 5-5

### Open the Export Interface

You can export a model to a Web view using either a Simulink Report Generator dialog box or a Report Explorer pane.

To Open the export interface from ...	Use ...	Export interface opens as...
Report Explorer	<b>Tools &gt; Export Simulink to Web</b>	Report Explorer
Simulink Editor	<b>File &gt; Export &gt; Export Model to Web</b>	Dialog box
Stateflow Editor	<b>File &gt; Export &gt; Export Model to Web</b>	Dialog box
Command line	The slwebview function, with no arguments	Report Explorer

### Set Export Options

You can set options that specify which Simulink systems or Stateflow charts to export to a Web view, including:

- Whether to export Simulink systems or Stateflow charts that include (or are children of) the current system or chart. For more information, see “Include Systems” on page 5-4.
- Which masked blocks, if any, to include. For more information, see “Look Under Masks” on page 5-4.

- Whether to follow links to library blocks. For more information, see “Follow Library Links” on page 5-5.
- Whether to follow model reference blocks. For more information, see “Follow Model Reference Blocks” on page 5-5.

---

**Tip** This section describes how to specify Web view export options using the Web Views dialog box. For information about how to specify these options using the command line, see the `slwebview` function reference page.

---

### Include Systems

Specifies which Simulink systems or Stateflow charts to export.

Include Systems Option Value	Meaning
Current	Export only the Simulink system that is open in the model window or the Stateflow chart that is open in the diagram editor
Current and above	Export the current Simulink system or Stateflow chart and all systems or charts that contain it
Current and below	Export the current Simulink system or Stateflow chart and all subsystems or subcharts that it contains
All (Default)	Export all Simulink systems or Stateflow charts in the model

### Look Under Masks

This option is available only when you choose `Current and below` or `All` for **Include Systems**. It specifies which masked blocks, if any, to export from Simulink subsystems or Stateflow subcharts.

<b>Look Under Masks Option Value</b>	<b>Meaning</b>
No masked blocks	Do not export any masked blocks
Masks with no workspace and no dialog (Default )	Export only graphical masked blocks—those that have no workspaces and no dialog boxes
Masks with no dialog	Export only functional masked blocks—those that have no dialog boxes
All masked blocks	Export all masked blocks

### **Follow Library Links**

Specifies whether to follow links into library blocks.

<b>Follow Library Links Option Value</b>	<b>Meaning</b>
Selected	Follow links into library blocks
Unselected (Default)	Do not follow links into library blocks

### **Follow Model Reference Blocks**

Specifies whether to follow links into referenced models.

<b>Follow model reference blocks Option Value</b>	<b>Meaning</b>
true	Follow links into referenced models
false (Default)	Do not follow links into referenced models

### **Generate and Review Web Views**

The Web view export process exports the system or chart that is visible at the time you click **Export Model**. If you change the visible system or chart while the Report Explorer Web view export pane is visible, the Report Explorer

pane does not automatically change to show information about the newly visible system. To update the Report Explorer pane, click **Refresh**.

The Web view export dialog box or the Report Explorer displays a list of layers — that is, Simulink systems or Stateflow charts—to export. The list of layers depends on the export options you specify, as described in “Set Export Options” on page 5-3.

To generate a Web view of all layers in the model, click **OK** in the Web View dialog box, or click **Export Model** in the Report Explorer pane. This action generates two sets of files in the current MATLAB folder:

- An HTML file to appear in a Web browser.
- A folder with the same name as the HTML file. This folder contains supporting files, such as svg and png files.

To send the Web view to another computer, include both the HTML file and the folder of supporting files. Package these items into a zip file for transfer.

When you generate a Web view, it appears in a Web browser by default. You can suppress the display by setting the 'ViewFile' option to `false`.



## Navigate Web Views

### In this section...

“Display Web Views” on page 5-7

“View the Current Layer” on page 5-7

“View Layers Below the Top Layer” on page 5-8

“View All Layers” on page 5-9

### Display Web Views

To display Web views, you need a Web browser with support for Scalable Vector Graphics (SVG), implemented natively or through a plug-in. For detailed information on software requirements and limitations for using Web views, see the *Simulink Report Generator Release Notes*.

A Web view display consists of:

- A graphical display of the current layer (Simulink system or Stateflow chart)
- A hierarchical treeview browser for easy navigation through layers
- Four navigation buttons at top left
- Menu of navigation commands, which appears when you move the mouse over the leftmost button
- Shortcut menu, which appears in some browsers when you right-click the current layer

### View the Current Layer

Display an example Web view of the Simulink Automatic Climate Control System model by typing the following commands at the MATLAB command prompt:

```
sldemo_auto_climatecontrol;  
slwebview(gcs)
```

As you move the mouse over the current layer, parameter names and values appear for each system, chart, block, and line. Use the mouse, menu commands, keyboard accelerators, and the arrow keys on your keyboard to pan and zoom within the current layer.

<b>Action</b>	<b>Navigation Menu Command</b>	<b>Shortcut Menu Command</b>	<b>Keyboard Accelerator</b>
Zoom in	<b>Zoom in</b>	<b>Zoom in</b>	<b><u>R</u></b>
Zoom out	<b>Zoom out</b>	<b>Zoom out</b>	<b><u>V</u></b>
Zoom to normal size (100%)	<b>Zoom to 100%</b>	None	<b><u>1</u></b>
Zoom to largest size that fits in browser window	<b>Zoom to full screen</b>	<b>Zoom to full screen</b>	<b><u>F</u></b>
Pan up	<b>Pan up</b>		<b><u>E</u></b>
Pan down	<b>Pan down</b>		<b><u>C</u></b>
Pan left	<b>Pan left</b>		<b><u>D</u></b>
Pan right	<b>Pan right</b>		<b><u>G</u></b>
Pan with mouse (drag layer while in panning mode)	<b>Pan with mouse</b> (click to toggle panning mode)	<b>Pan with mouse</b> (click to toggle panning mode)	<b><u>P</u>, <u>Q</u>, or <b>SPACEBAR</b></b> (press to enter panning mode; release to exit panning mode)

---

**Note** The shortcut menu command **Find text** searches for a text string in the current layer. This command is only available in the Microsoft Internet Explorer Web browser.

---

## **View Layers Below the Top Layer**

Click a particular layer's subsystem or subchart to make it the current layer. The current layer is also selected in the treeview browser, and its subsystems

or subcharts appear in the treeview browser hierarchically. If blocks in your current layer are linked to libraries, the Web view shows to which libraries they belong.

---

**Note** If your current layer has no subsystems or subcharts, it does not appear in the treeview browser.

---

As you move the mouse over an exported subsystem or subchart, it is highlighted or the cursor changes, depending on which Web browser you are using. You also see the following visual cues that enable you to assess your location in the model quickly:

- The subsystem or subchart's corresponding icon in the treeview browser is also highlighted, showing to where in the hierarchy you have navigated.
- The names of the subsystem or subchart's parent systems are grayed out and italicized in the treeview browser.

You can use the navigation buttons at the top left to view other layers.

Action	Navigation Button
View the previous layer in the view history	<b>View previous</b>
View the top-level layer	<b>View home</b>
View all layers in one window	<b>View all layers</b>

## View All Layers

Click the **View all layers** navigation button to view all layers in one window. The layers appear in the Web browser as thumbnail images. You can click a given layer to view details about it. Clicking the **View all layers** button again returns to the previous view.

---

**Tip** You can also view all layers by selecting the **Show all layers** command on the navigation and shortcut menus, and by using the **X** keyboard accelerator.

---

## Create Web Views of Simulink Models

In this section...
“About This Tutorial” on page 5-11
“Specify Web View Export Options” on page 5-11
“Export Models” on page 5-13
“Navigate Web Views” on page 5-14

### About This Tutorial

This tutorial takes you through the steps required to export a Simulink model to a Web view. If you have a detailed model of your own, you can use it for this example. Otherwise, use the example provided in this section.

There are several ways to create a Simulink model Web view. This tutorial creates a Web view from the Simulink model window using the `sldemo_auto_climatecontrol` model, which is provided with the Simulink software. This model simulates the working of an automatic climate control system in a car.

You do not need to know the Simulink product to follow this tutorial.

### Specify Web View Export Options

Before creating the Web view, specify export options:

- 1 Start a MATLAB software session.
- 2 At the command prompt, enter `sldemo_auto_climatecontrol` to open the Simulink model.
- 3 Click **File > Export > Export Model to Web**.

A Web view window that includes data about the current model appears.

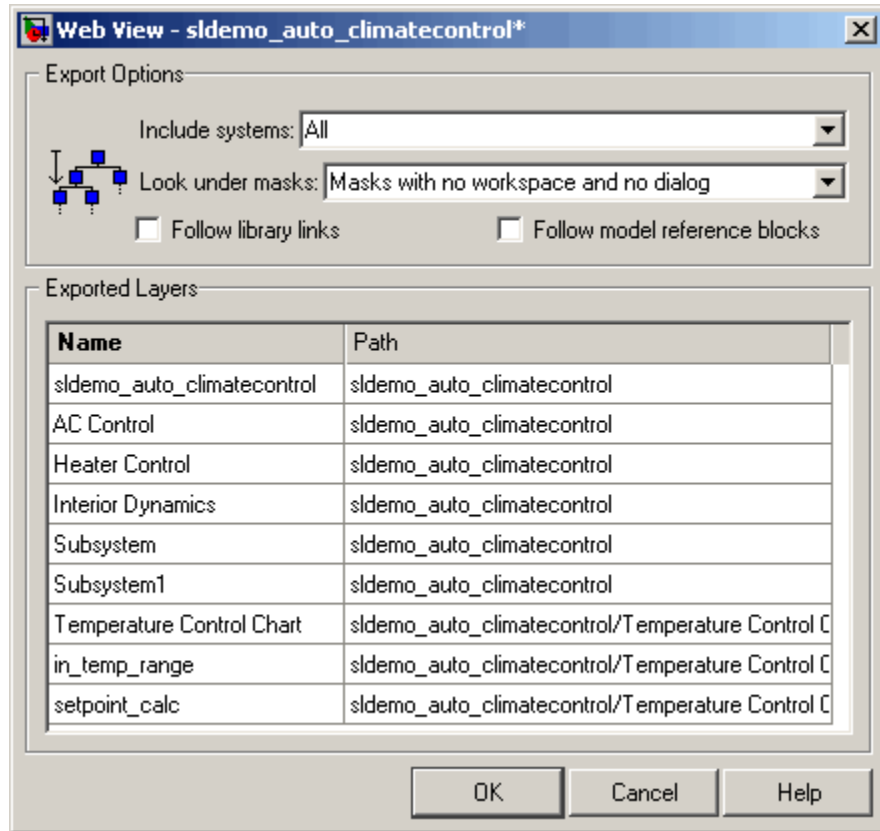

- 4** In the **Include systems** selection list, select **All** to export all systems in this model.
- 5** In the **Look under masks** selection list, select **Masks with no workspace and no dialog** to export only graphically masked blocks.
- 6** Leave the **Follow library links** and **Follow model reference blocks** check boxes cleared.

**Exported Layers** appears in the lower part of the Web View window. This area lists the names of the systems to export to the Web view, along with their Simulink paths. Because you selected **All** in the **Include systems** selection list, all layers in the `sldemo_auto_climatecontrol` model appear.



### Navigate Web Views

You can navigate Web views in ways similar to how you navigate models in the Simulink GUI. The following steps help you experiment with the types of navigation that are available.

- 1 Notice the four navigation icons in the upper-left corner of the browser window.

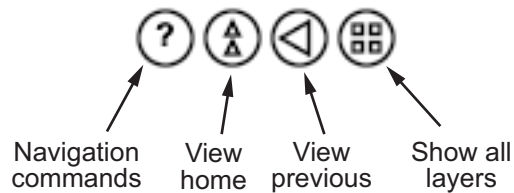

- 2 Hover over the Navigation Commands icon  to see a list of keyboard shortcuts that allow you to move around the current window.



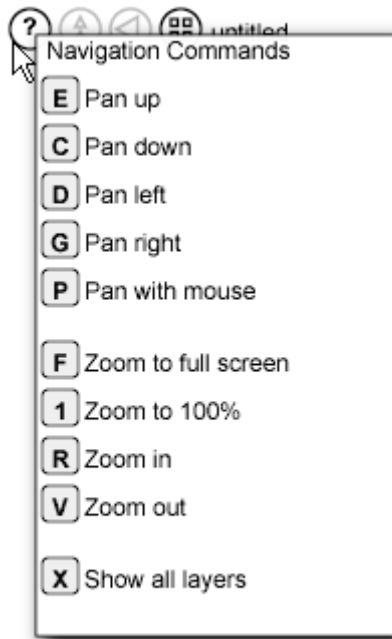

- 3** Press some of the keyboard keys listed here to see how the model in the Web view reacts.
- 4** Hover over the Temperature Control Chart diagram.

## 5 Export Simulink® Models to Web Views

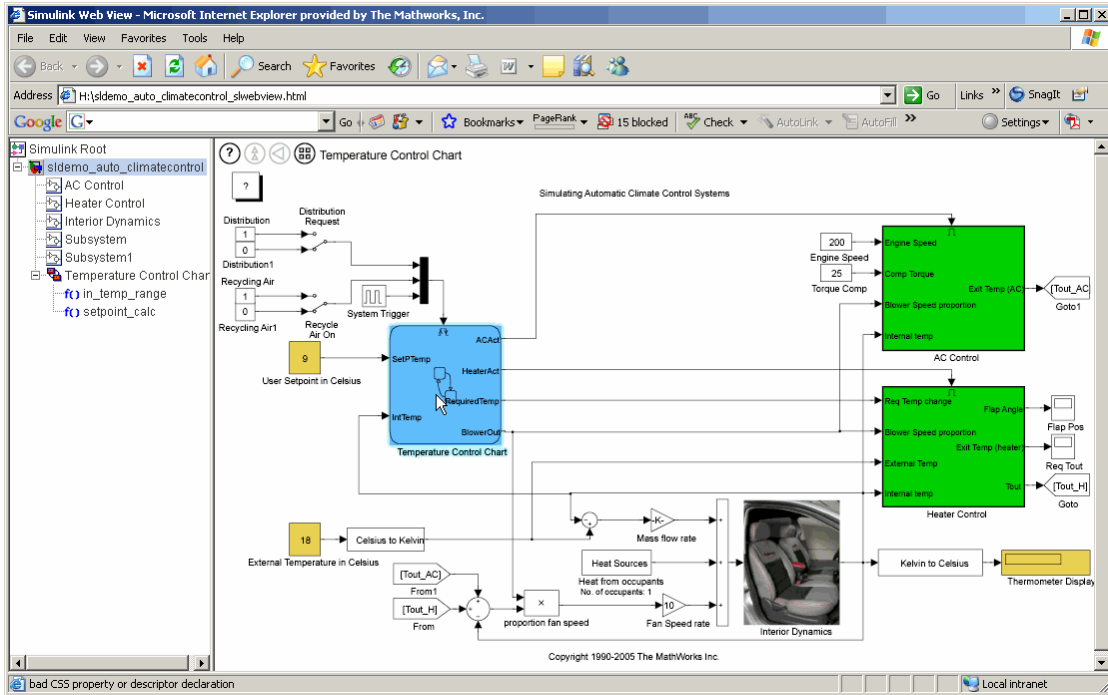

The name next to the navigation icons becomes Temperature Control Chart.



5 Hover over the System Trigger block.

The name next to the navigation icons changes to System Trigger.



In addition, the block parameter values for the System Trigger block appear.

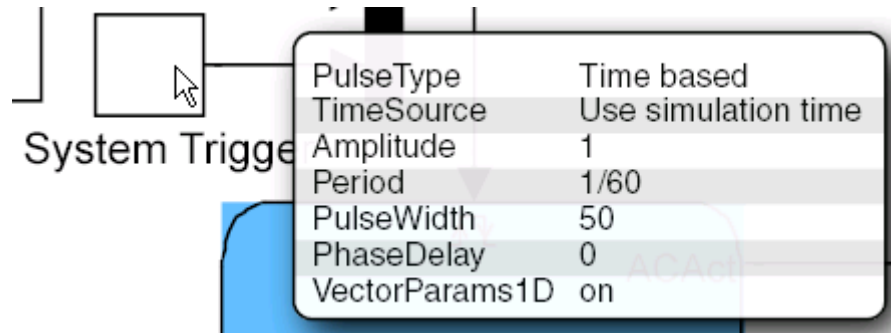

- 6 Hover over other blocks and subsystems in the model and observe the results.
- 7 Click the Temperature Control Chart.

The details of this Stateflow chart appear, and the middle two navigation icons are now enabled:

- The **View Home** icon takes you up to the top level of the model.
- The **View Previous** icon takes you back to the previously displayed level in the model.

## 5 Export Simulink® Models to Web Views

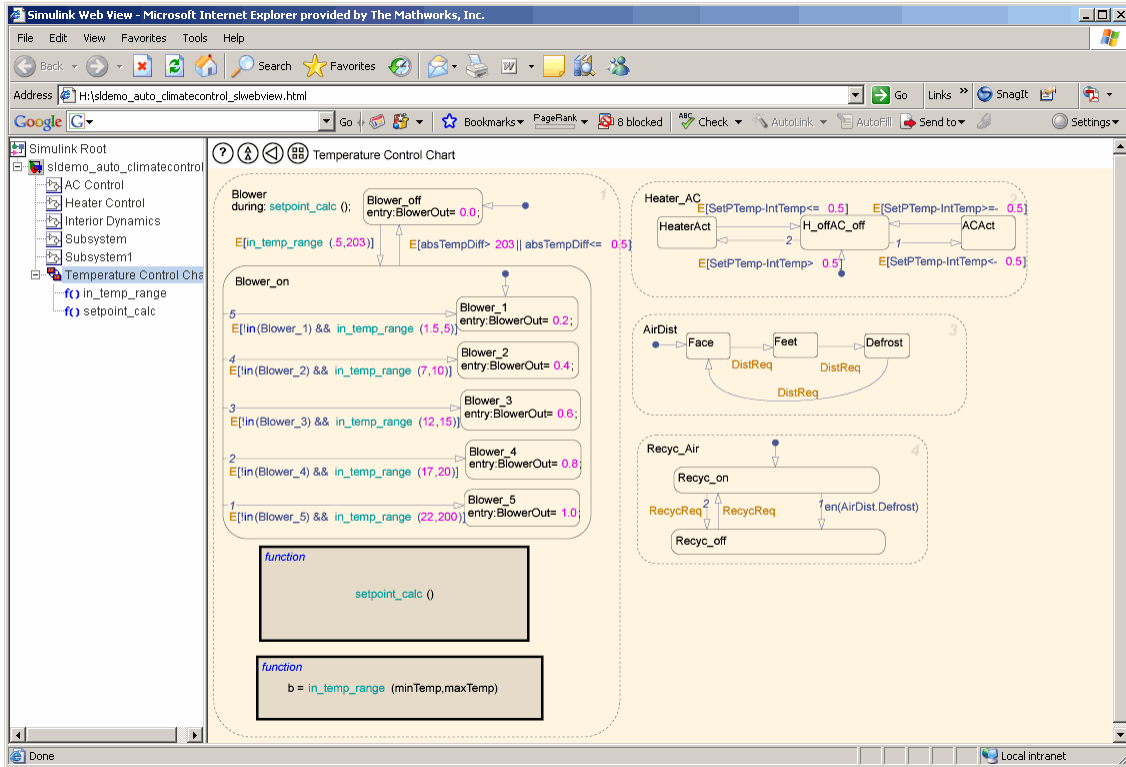

- 8 Click the `setpoint_calc` box in the Stateflow chart to see the details of that block.

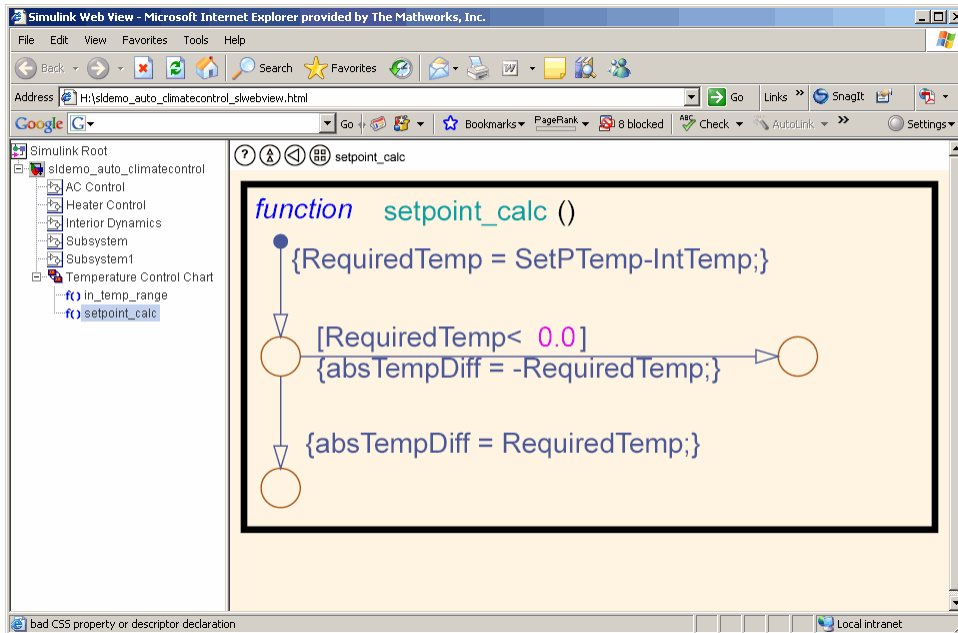

9 Click the **View home** icon to return to the model's top layer.

10 Click the **Show all layers** icon. An overall view of the model appears.



# Troubleshooting Web Views

## Web View Display Issues

Exporting a Simulink model to a Web view may produce the following error:

```
[Thu Aug 23 15:20:04 2007] [alert] [client 127.0.0.1]
/webserver/mydir/simulink_model_slwebview_files/.htaccess:
IndexIgnore not allowed here
```

This results in your Web browser failing to display the Web view.

This issue occurs because of settings specified in the `.htaccess` file in your Web browser's root folder. This file contains the Apache Web Server settings for your Web server host. To fix this problem, delete this file or remove the `IndexIgnore *` line from it.





# Add Content with Components

---

- “Components” on page 6-2
- “Report Structure Components” on page 6-4
- “Table Formatting Components” on page 6-5
- “Property Table Components” on page 6-6
- “Summary Table Components” on page 6-17
- “Dynamic Reporting Components” on page 6-22

## Components

Components are MATLAB objects that specify the content of a report. Add components to specify the types of content that commonly occur in reports. The MATLAB Report Generator provides a set of components for specifying the types of content that commonly occur in MATLAB-based reports. The Simulink Report Generator provides additional components to facilitate generation of reports from Simulink models. You can also create custom components to handle content specific to your application.

Using the Report Explorer, you can interactively combine components to create a report setup that specifies the content of a particular report or type of report. For general information about working with components, see:

- “Insert Components”
- “Set Component Properties”

Use a combination of the following types of components in your report setup file, based on your goals for the report.

Type of Component	Description
“Report Structure Components” on page 6-4	Include a title page, chapters, sections, paragraphs, lists, tables, and other standard document structure elements.
“Table Formatting Components” on page 6-5	Organize generated content into tables.
“Property Table Components” on page 6-6	Display tables with property name/property value pairs for objects.
“Summary Table Components” on page 6-17	Display tables with specified properties for objects.
“Dynamic Reporting Components” on page 6-22	Run child components a specified number of times. There are several looping components, including logical loops and Handle Graphics loops.

## **Control Format with Stylesheets**

When you generate a report, a stylesheet formats the content specified by these components to reflect the document organization. For example, a report stylesheet typically uses different font sizes for chapter titles and section titles.

In the report setup, specify the stylesheet to use to format your report . You can change the format of your report by modifying the specified stylesheet or selecting another stylesheet. For details, see “Report Output Format and Stylesheet”.

## **Control Format at the Component Level**

The output format and the stylesheet that you select for a report determines most aspects of the formatting of the generated report. For details, see “Report Output Format and Stylesheet”.

Several components include properties that you can set to specify formatting details for that specific instance of a component. For example, for the `MATLAB Property Table`, you can specify formatting such as whether to display table borders or the alignment of text in table cells.

## Report Structure Components

Use report structure components to organize the content of your report into chapters, sections, paragraphs, lists, tables, and other standard document structure elements. The following table summarizes the report structure components.

Component	Usage
Title Page	Generate a title page for a report.
Chapter/Subsection	Parent components that generate the content of a chapter or chapter subsection.
Paragraph	Specify the content and text format of a paragraph of text. Can serve as the parent of one or more text components, enabling use of multiple text formats (for example, bold, regular, or italic) in the same paragraph.
Text	Format strings of generated text.
List	Generate a list from a cell array of numbers or strings or parent components (for example, Paragraph components) that specify the items in a list. You can create multilevel lists by embedding list components within list components.
Link	Generate a hyperlink from one location in a report to another or to an external location on the user's file system or the Worldwide Web.
Image	Insert an image into a report.
Array-Based Table	Generate a table from a cell array of numbers or strings.
Table	Parent a table body component. See "Table Formatting Components".

## Table Formatting Components

Use table formatting components to organize generated content into tables. The following table summarizes the table formatting components.

Component	Usage
Table	Parent a table body component. Can also parent column specification components and a table header and a table footer component. Specifies properties of the table as a whole (for example, its title, number of columns, and border).
Table Body	Parent the rows that make up the table body. Specifies the default vertical alignment of entries in a table body.
Table Column Specification	Specify attributes of a table column, such as its width and borders and the default horizontal alignment of column entries.
Table Entry	Parent a component that determines a table entry's content, such as a paragraph, image, list, or another table component. Specifies attributes of a table entry, such as the number of rows and columns that it spans.
Table Footer	Parent the row components that generate the content of a table footer.
Table Header	Parent the row components that generate the content of a table header.
Table Row	Parent the table entry components that generate the content of a table row.

---

**Tip** Inserting a Table component into a setup also inserts all the descendant components required to generate a 2x2 table, creating a table template. Edit this template to create a table that suits your needs.

---

## Property Table Components

In this section...
“About Property Table Components” on page 6-6
“Open the Example Report Template” on page 6-8
“Examine the Property Table Output” on page 6-8
“Select Object Types” on page 6-9
“Display Property Name/Property Value Pairs” on page 6-9
“Edit Table Titles” on page 6-12
“Enter Text into Table Cells” on page 6-12
“Add, Replace, and Delete Properties in Tables” on page 6-13
“Format Table Columns, Rows, and Cells” on page 6-14
“Zoom and Scroll” on page 6-16
“Select a Table” on page 6-16

### About Property Table Components

Property Table components display property name/property value pairs for objects in tables. The following example shows a property table from the `figloop-tutorial` report.

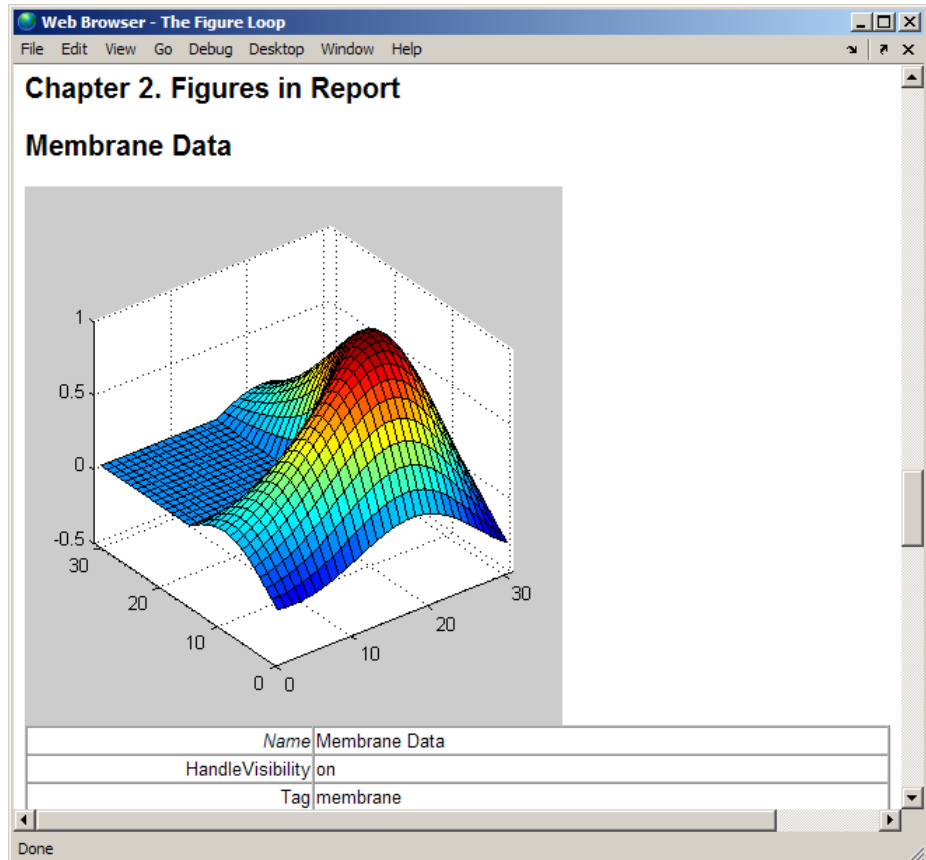

Many types of property table components are available, including:

- MATLAB Property Table
- Simulink Property Table (requires Simulink Report Generator)
- Stateflow Property Table (requires Simulink Report Generator)

The component used in this example represents MATLAB Report Generator property table components, all of which exhibit similar behavior.

### Open the Example Report Template

This example uses the `figloop-tutorial` report template. To open the figure loop tutorial report template, at the MATLAB command line enter:

```
setedit figloop-tutorial
```

### Examine the Property Table Output

Property pages for all property table components are similar in form. In the Outline pane, select the Figure Prop Table component. To modify table settings, in the Handle Graphics Property Table dialog box, click the **Edit...** button.

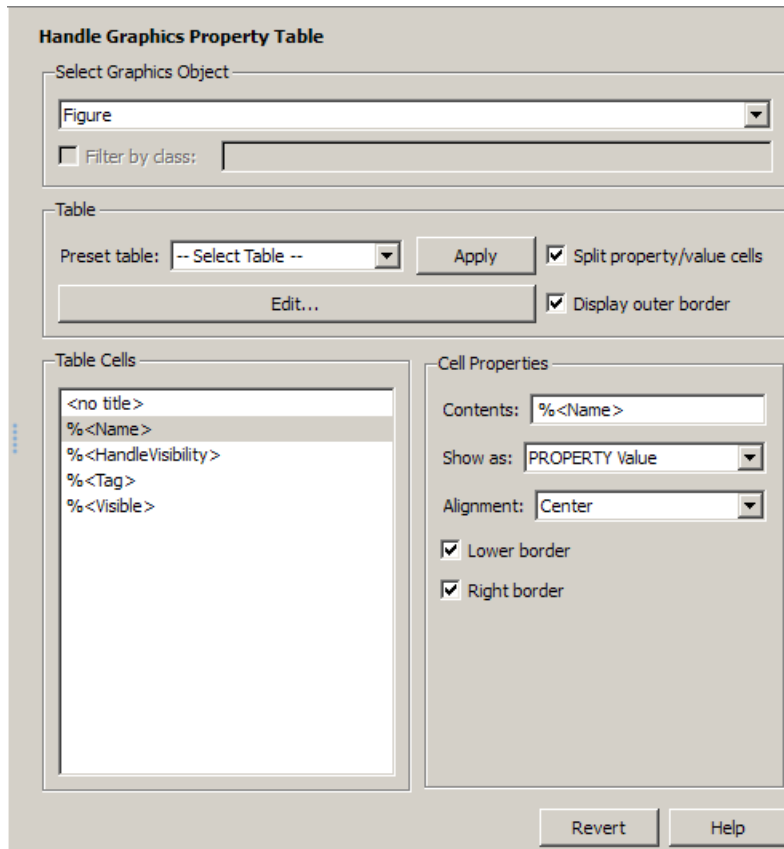



## Select Object Types

Property table components offer multiple object types on which to report. For example, the Handle Graphics Property Table lets you report on a figure, an axes object, or a Handle Graphics object.

You can select a different object type on which to report in the **Object type** list in the Properties pane for the component.

## Display Property Name/Property Value Pairs

### Split Property/Value Cells

- 1 In the Properties pane for the Handle Graphics Property Table component, clear the **Split property/value cells** check box.
- 2 Click **Edit**. The table is now in *nonsplit mode*. Nonsplit mode supports more than one property name/property value pair per cell and text.

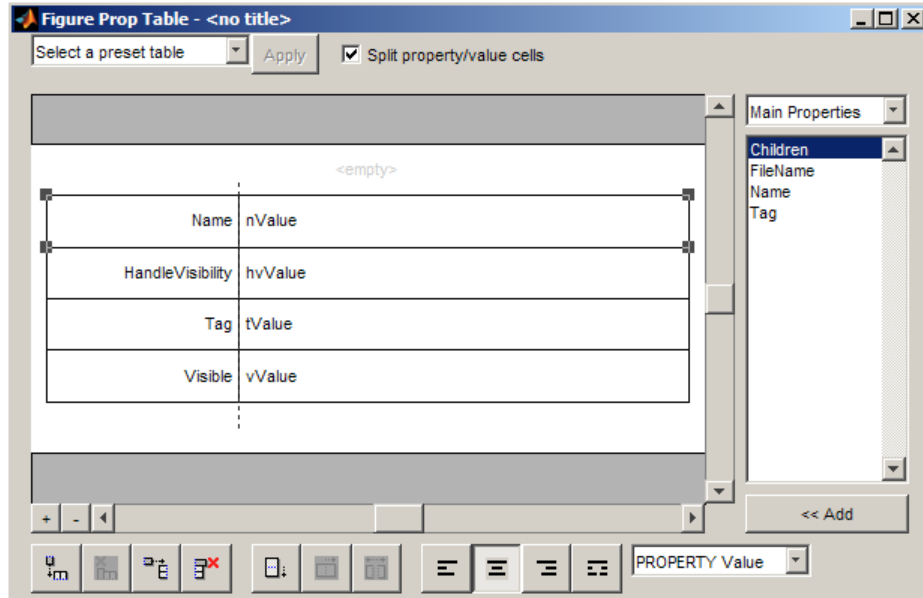

- For the property name and property value to appear in adjacent horizontal cells in the table, select the **Split property/value cells** check box. The table is now in *split mode*. Split mode supports only one property name/property value pair per cell. If more than one property pair appears in a cell, only the first pair appears in the report; all subsequent pairs are ignored.

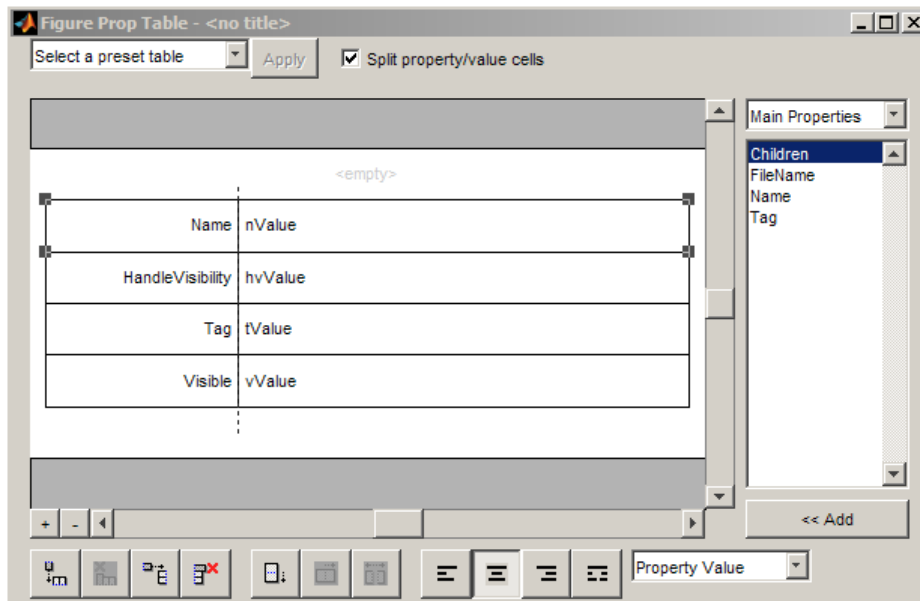

### Display Options

Property name/property value pairs can appear in cells in several ways. To specify how a given property name/property value pair appears in a cell, select that field in the table (for this tutorial, select the Name property). Choose Value from the display options drop-down list at the bottom of the dialog box. In the selected table row, only the value appears.

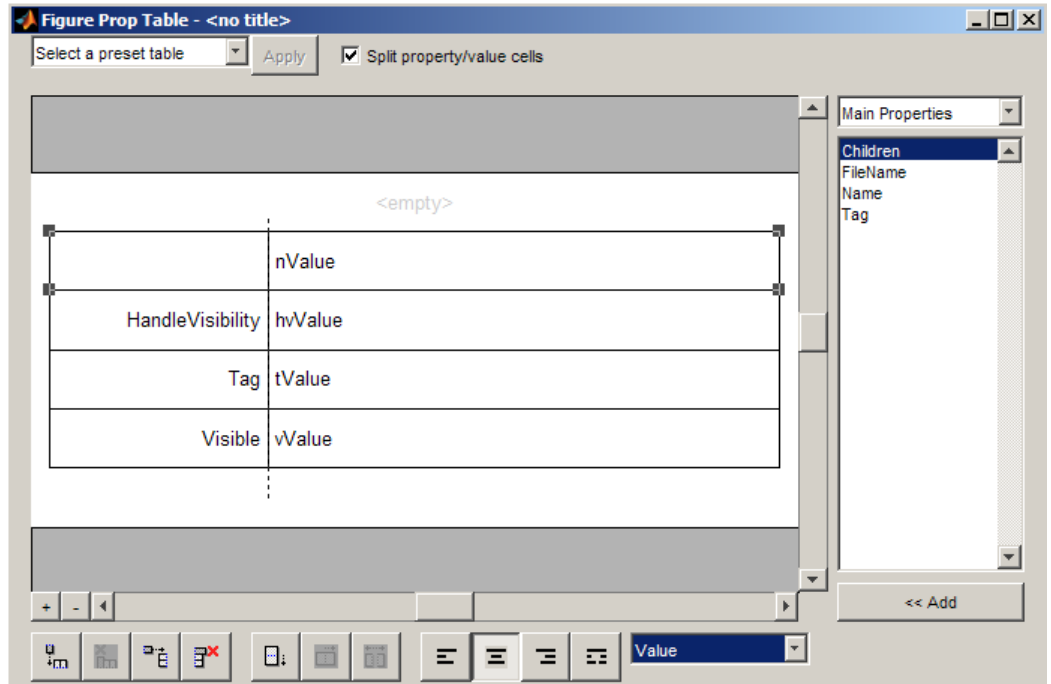

### Format Options

To specify alignment for text in a given cell, in the toolbar at the bottom of the dialog box use the four justification buttons.

Select the `HandleVisibility` table row. Then select the double-justify button (the last button to the right).

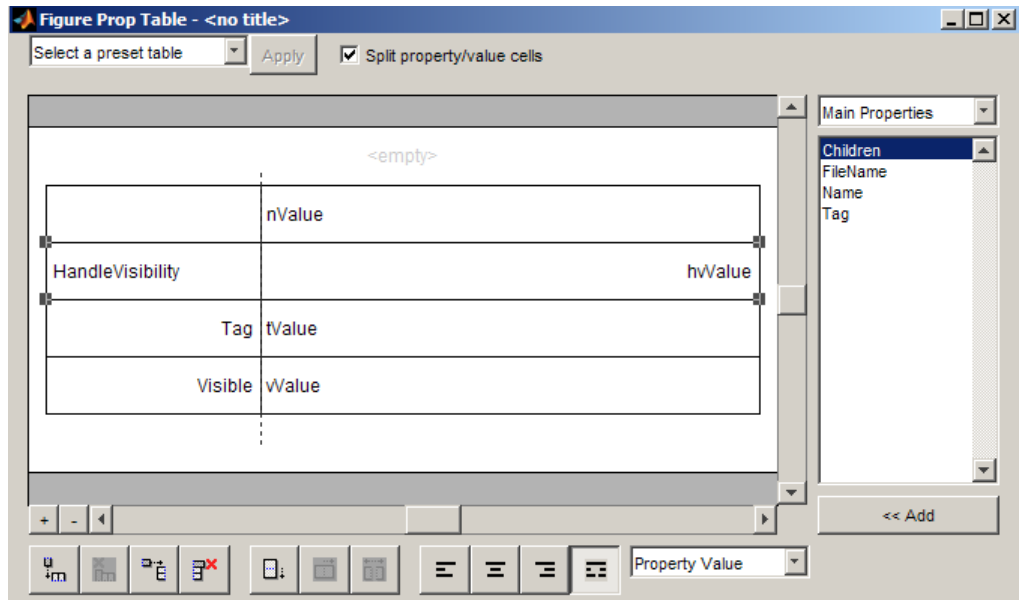

### Edit Table Titles

Table titles can contain properties and text. By default, the title of a table is the same as the value of the %<Name> property. You can modify this property to modify the table title.

---

**Note** Table titles are always in nonsplit mode.

---

### Enter Text into Table Cells

For the text to be visible, the table must be in nonsplit mode. Clear **Split property/value cells**.

To enter text into the `HandleVisibility` table cell, double-click the cell. A gray box appears with the label for the cell property.

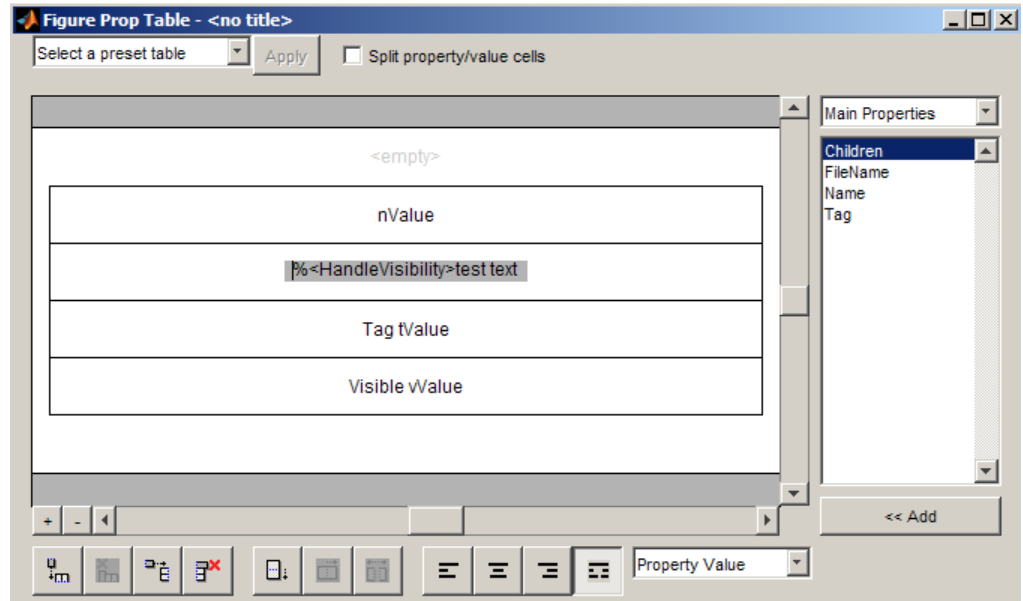

If you type text outside the angle brackets, the text appears as is in the report. Text inside the table brackets must specify a valid property name. If you enter an invalid property name, the property name appears in the report without a property value.

## Add, Replace, and Delete Properties in Tables

### Adding Table Properties

To add a Handle Graphics property to a table, use the following steps.

- 1 In the Figure Property Table window, select a table row above which you want add a new property.

- 2 Click the Add Row Above Current Cell  button

A new row appears above the current row.

- 3 Add the property to the new table row.
  - a Select the new table row.
  - b In the Properties Type drop-down list at the upper-right of the dialog box, select a property type.
  - c In the **Properties** list, select the property you want to add.
  - d Click the << **Add** button, or double-click the property name. The property appears in the table row.

Alternatively, if you know the name of the property you want to add, enter the property name directly into the cell as described in “Enter Text into Table Cells”. For information about adding new table rows, see “Add and Delete Columns and Rows”.

### Replace Table Properties

To replace a property in a cell of a table in split mode, follow the instructions in “Adding Table Properties” on page 6-13.

---

**Note** You cannot use these steps to delete a property in a cell when the table is in nonsplit mode.

---

### Delete Table Properties

Delete a property by backspacing over it or using the **Delete** key.

## Format Table Columns, Rows, and Cells





### Add and Delete Columns and Rows

To add or delete a column or row, select a cell and then click one of the buttons described in the following table.

---

**Note** You cannot delete a row or column when it is the only row or column in the table.

---



Button	Action
	Add column (added to the left of the selected column)
	Delete selected column
	Add row (added above the selected row)
	Delete selected row

### Resize Columns

To resize the width of a column, click and drag its vertical borders as needed.

### Merge and Split Cells

To merge or split table cells, select a row and then click one of the buttons described in the following table.

Button	Action
	Merge cells downward
	Merge cells to the right
	Split cells

### Display or Hide Cell Borders



To toggle cell borders on and off:

- 1 Place your cursor in a cell and right-click to invoke its context menu.

- 2 Choose **Cell borders > Top, Bottom, Right, or Left** to toggle the specified border on or off.

### Zoom and Scroll

You can zoom in and out of the table with the zoom buttons, which are located to the left of the horizontal scroll bar.

Button	Action
	Zoom in
	Zoom out

You can scroll vertically and horizontally using the table scroll bars.

### Select a Table

To display property name/property value pairs, you can select a preset table or use a custom table.

- A preset table is built-in and formatted. You can select a preset table in the preset table selection list in the upper-left of the Figure Prop Table window. To apply a preset table, select the table and click **Apply**.
- To create a custom table, select a preset table and modify it to fit your needs by adding and/or deleting rows and properties. You may want to start with the **Blank 4x4** preset table.

---

**Note** You cannot save a custom table as a preset table. If you do so, you lose all changes to the custom table.

---



## Summary Table Components

In this section...
“About Summary Table Components” on page 6-17
“Open the Example Report Template” on page 6-19
“Select Object Types” on page 6-19
“Add and Remove Properties” on page 6-19
“Set Relative Column Widths” on page 6-20
“Set Object Row Options” on page 6-20

### About Summary Table Components

Summary table components insert tables that include specified properties for objects into generated reports. Summary tables contain one object per row, with each object property appearing in a column, as shown in the following summary table in the `figloop-tutorial` report.

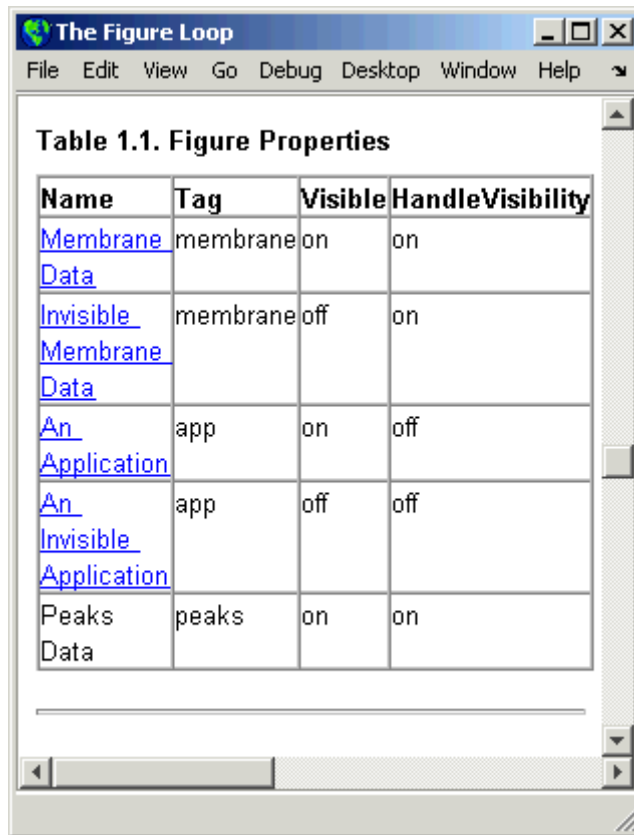

**Table 1.1. Figure Properties**

Name	Tag	Visible	HandleVisibility
<a href="#">Membrane Data</a>	membrane	on	on
<a href="#">Invisible Membrane Data</a>	membrane	off	on
<a href="#">An Application</a>	app	on	off
<a href="#">An Invisible Application</a>	app	off	off
Peaks Data	peaks	on	on

Many types of summary table components are available, including:

- Handle Graphics Summary Table
- Simulink Summary Table (requires Simulink Report Generator)
- Stateflow Summary Table (requires Simulink Report Generator)

The component used in this example represents MATLAB Report Generator summary table components, all of which exhibit similar behavior

## Open the Example Report Template

This example uses the `figloop-tutorial` report template. To open the figure loop tutorial report template, enter the following at the MATLAB command line:

```
setedit figloop-tutorial
```

## Select Object Types

You can use the **Object type** selection list to choose Handle Graphics object types for the summary table, including blocks, signals, systems, and models. The `figloop-tutorial` reports on figure objects.

## Add and Remove Properties

You can select object properties to appear in the summary table from the Property Columns pane. To add a property to the summary table, select the property category from the property category drop-down box to the right of the **Property columns** table. Each property category has its own list of properties, which appear in the field under the box. The following figure shows Main Properties as the selected category.

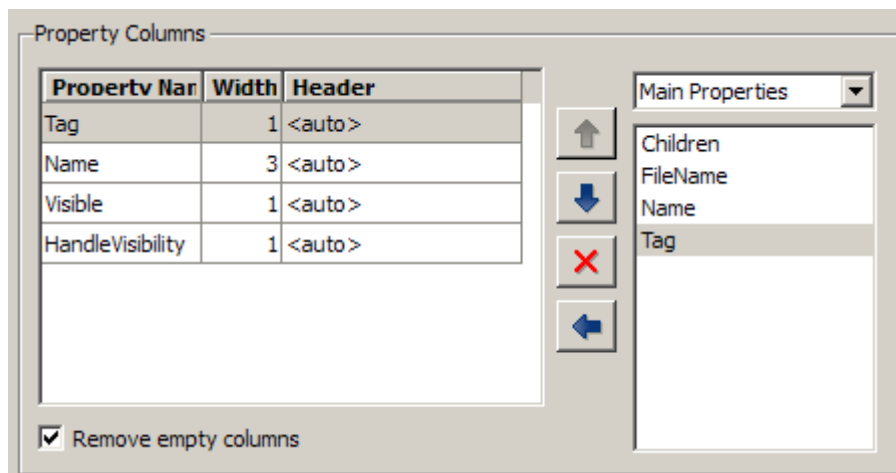

To add a property:

- 1 Select the category from the property category drop-down box.
- 2 Select a property in the properties list.
- 3 Click the Add property  button.

The property appears in the **Property columns** table.

To remove a property from the table:

- 1 Select the property in the **Property columns** table.
- 2 Click the Delete property  button.

The property name is removed from the **Property columns** table.

---

**Note** After making changes in the Report Explorer interface, click **Apply** to make the changes take effect.

---

You can define your own properties by entering their names into the **Property columns** table using valid variable notation. For more information, see “% Notation” on the Text component reference documentation.

### Set Relative Column Widths

To apply a relative column width to the summary table columns in the generated report, double-click on the Width column of a row in the **Property columns** table . If you do not specify a value for this field, column widths automatically set.

### Set Object Row Options

You can use the Object Rows pane to set options for table rows, including anchor, filtering, and sorting options. Select **Insert anchor for each row** to place an anchor in each table row in the report. Use the **Include figures** list to specify what objects to include in the summary table.

Summary table components in `figloop-tutorial` report on figure objects. For more information on options for these figure objects, see the following sections:

- “Loop on the Current Figure” on page 6-25
- “Loop on Visible Figures” on page 6-25
- “Loop on Figures with Tags” on page 6-25

## Dynamic Reporting Components

In this section...
“Logical and Looping Components” on page 6-22
“Edit Figure Loop Components” on page 6-22

### Logical and Looping Components

Logical and looping components execute conditionally, enabling you to decide when a child component executes or how many times a child component executes.

A *looping component* runs its child components a specified number of times. There are several looping components, including logical loops and Handle Graphics loops.

A *looping component* runs its child components a specified number of times. There are several looping components, including logical loops, Handle Graphics loops, and model and chart loops. For model and chart loops, you can control aspects such as the order in which the report sorts blocks.

The following example uses the Figure Loop, which is representative of many types of loops. The Figure Loop component runs its child components several times. In each iteration, it applies its child components to Handle Graphics figures. The `figloop-tutorial` report setup file, included with the MATLAB Report Generator software, creates a report that documents multiple Handle Graphics figures.

### Edit Figure Loop Components

- 1 Open an example report setup file that illustrates using looping components. At the MATLAB command prompt, enter:

```
setedit figloop-tutorial
```

- 2 To display the Handle Graphics figures, enter the following at the MATLAB command line:

### figloopfigures

The figures Membrane Data, An Application, and Peaks Data appear on the screen because their visible property is 'on'. The Invisible Membrane Data and An Invisible Application figures do not appear on screen because their visible property is 'off'. These invisible figures exist, but they are hidden.

“Figure Properties” on page 6-24 describes the properties of figures used in this tutorial.

- 3** In the Report Explorer, in the Outline pane on the left, select the Figure Loop component called Figure Loop Section 1.

The Properties pane for the Figure Loop component appears.

**Figure Loop**

Figure Selection

Include figures: All figures with tags: ▾

- app
- membrane

Match with regular expressions

Loop Figure List

- Membrane Data
- Invisible Membrane Data
- An Application
- An Invisible Application

Section Options

- Create section for each object in loop
- Display the object type in the section title
- Create link anchor for each object in loop

Revert Help

### Figure Properties

You can control what figures get displayed in the report, based on the properties of each figure.

Table 1.1 of the `figloop-tutorial` report includes a summary of the properties of the figures used in this tutorial.



**Table 1.1. Figure Properties**

Name	Tag	Visible	HandleVisibility
<a href="#">Membrane Data</a>	membrane	on	on
<a href="#">Invisible Membrane Data</a>	membrane	off	on
<a href="#">An Application</a>	app	on	off
<a href="#">An Invisible Application</a>	app	off	off
Peaks Data	peaks	on	on

For this tutorial, you do not change these properties. For background information, see “Setting and Querying Property Values” in the MATLAB documentation.

### Loop on the Current Figure

To include only the current figure in the report, select `Current figure` only from the **Include figures** selection list. In this case, “current figure” refers to the figure that is current when the report generates. This may not be the same figure you selected as the current figure in the Report Explorer before report generation. For example, if the report generation process creates figures in your report, the last figure created with `HandleVisibility` set to 'on' is the current figure.

### Loop on Visible Figures

To include snapshots of all visible figures in your report, select `Visible figures` in the **Include figures** selection list. This option inserts a snapshot and Property Table for all figures that are currently open and visible.

- 1 Select the **Data figures only (Exclude applications)** option to exclude figures from the loop whose `HandleVisibility` parameter is 'off'.
- 2 To generate the report, in the Report Explorer toolbar click the **Report** button .

In the generated report, scroll down to “Chapter 2 Figures in Report.” The `Membrane Data` and `Peaks Data` figures appear in the generated report.

### Loop on Figures with Tags

To include figures with specified tags in the report:

- 1 Select the **All figures with tags** option in the **Include figures** selection list.
- 2 In the list of tags, delete **membrane**.
- 3 Click **Report** to generate the report.

The **An Application** and **An Invisible Application** figures appear in the report. They both have an **app** tag.

### Modify Loop Section Options

In a loop, a *section* refers to a space in the generated report in which information, including text, images, and tables, appears. You can alter the appearance of sections in each loop appear in the report by using the options in the **Figure Loop** component's **Section Options** pane.

**Create Section for Each Object in Loop.** With this option selected, the loop automatically creates an individual section for each object found in the loop. It uses the object title as the section title. This option is useful when a loop does not contain a **Chapter/Subsection** component that organizes the loop results.

**Display the Object Type in the Section Title.** Enable this option by selecting **Create section for each object in loop**. The generated report precedes section titles with object titles.

- 1 Enter **membrane** back in the list of tags.
- 2 Generate the **figloop-tutorial** report.

The figures produced by the loop are:

```
Membrane Data
Invisible Membrane Data
An Application
An Invisible Application
```

- 3 Enable the **Display the Object Type in the Section Title** option.
- 4 Generate the **figloop-tutorial** report.

The figures produced are now:

Figure - Membrane Data  
Figure - Invisible Membrane Data  
Figure - An Application  
Figure - An Invisible Application

The figures produced are now:

Figure - Membrane Data  
Figure - Invisible Membrane Data  
Figure - An Application  
Figure - An Invisible Application

**Create a Link Anchor for Each Object in Loop.** Selecting this option creates a hyperlink to the object in the generated report.



# Compare Simulink Model XML Files

---

- “Compare Simulink Model XML Files” on page 7-2
- “Explore the XML Comparison Report for Simulink Models” on page 7-10
- “Export, Print, and Save XML Comparison Results” on page 7-24
- “Compare XML from Models Managed with Subversion” on page 7-27

## Compare Simulink Model XML Files

In this section...
“Introduction” on page 7-2
“Overview of XML Comparison” on page 7-3
“Select Files to Compare” on page 7-5
“Choose a Comparison Type” on page 7-7
“Compare XML Files from Models with Identical Names” on page 7-7
“Examples of XML Comparison” on page 7-8

### Introduction

You can use Simulink Report Generator software to compare XML text files from Simulink models.

You can select a pair of Simulink models to compare their XML files. The XML comparison tool produces a comparison report based on the SLX files. You can use the report to explore the differences and view the changes highlighted in the original models.

You can access the XML comparison tool from:

- The MATLAB Current Folder browser context menu
- The MATLAB Comparison Tool
- The MATLAB command line
- The Simulink Model Editor **Tools** menu
- The Simulink Project Modified Files view

The XML comparison tool compares the XML files using the “Chawathe” algorithm, as described in the paper:

*Change Detection in Hierarchically Structured Information*, Sudarshan Chawathe, Anand Rajaraman, and Jennifer Widom; SIGMOD Conference, Montreal, Canada, June 1996, pp. 493-504.

This conference paper is based upon work published in 1995: see <http://dbpubs.stanford.edu:8090/pub/1995-45>.

The Simulink Report Generator XML comparison functionality is an extension of the MATLAB Report Generator XML comparison feature.

You can use the XML comparison tool with both model file formats, SLX and MDL. If the selected files are .mdl files, the XML comparison tool first exports the .mdl files to SLX files in a temporary directory. The XML comparison tool then produces a comparison report based on the SLX files.

## **Overview of XML Comparison**

You can display XML comparison reports in the MATLAB Comparison Tool. The comparison tool processes the output of the XML comparison into an interactive report with links that you can click to reverse annotate from the XML tag comparison to the corresponding Simulink models. “Reverse annotation” means when you click items in the report, Simulink Report Generator displays the corresponding items highlighted in the original models, as shown in the following example.

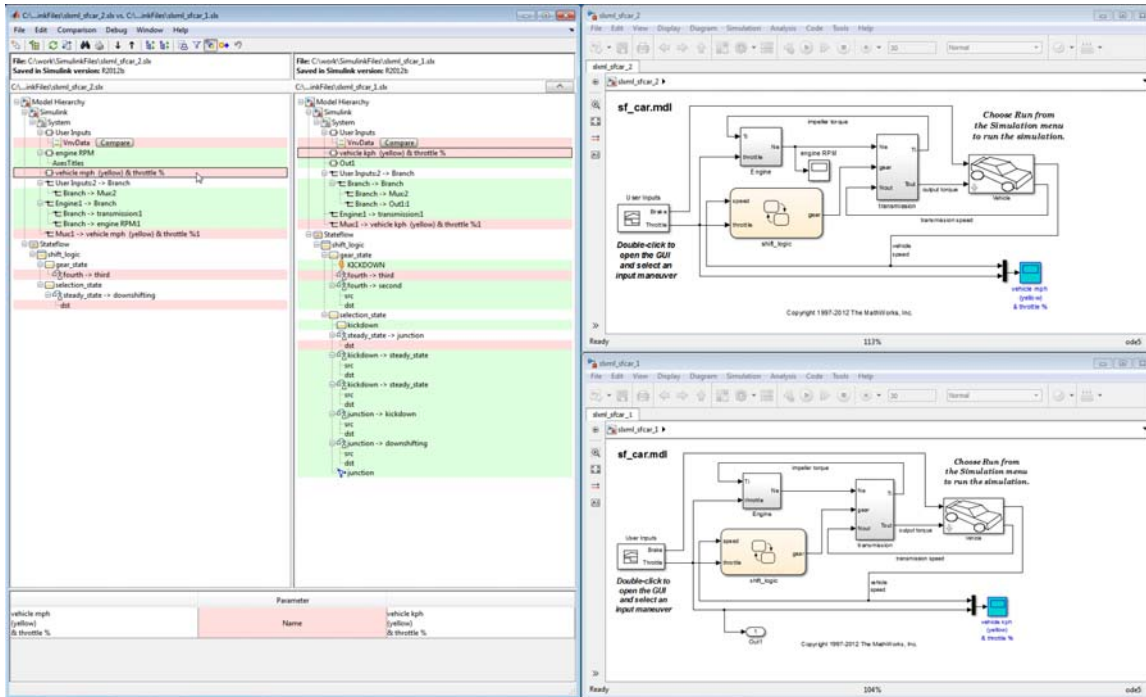

The XML comparison report shows a hierarchical view of the portions of the two XML files that differ. The report does not show sections of the files that are identical.

If the files are identical you see a message reporting there are no differences.

If files have not been saved, you see an error message informing you that you must save modified or newly created models before running an XML comparison.

---

**Note** It might not be possible for the analysis to detect matches between previously corresponding sections of files that have diverged too much.

---

Change detection in the Chawathe analysis is based on a scoring algorithm. Items match if their Chawathe score is above a threshold. The Simulink



Report Generator implementation of Chawathe's algorithm uses a comparison pattern that defines the thresholds assigned to particular node types (e.g., "block"). For more information, see "How the Matching Algorithm Works" in the MATLAB Report Generator documentation.

For more information on the display of special cases, see "Understand the Report" on page 7-20.

For more information about the Comparison Tool, see "Comparing Files and Folders" in the MATLAB documentation.

## Select Files to Compare

- "From the Simulink Editor" on page 7-5
- "From the Current Folder Browser" on page 7-5
- "From the Comparison Tool" on page 7-6
- "From a Simulink Project" on page 7-6
- "From the Command Line" on page 7-6

### From the Simulink Editor

To compare files using the Simulink Editor:

#### 1 Select **Analysis > Compare Simulink XML Files**.

The Compare Simulink XML Files dialog box opens.

#### 2 If the Editor currently displays a model, the current model name and path appear automatically selected in the **Left model file** edit box. Use the browse buttons to locate and select files for the left and right model files.

#### 3 When you click **OK**, the XML comparison tool performs the analysis, and displays the resulting report in the Comparison Tool.

### From the Current Folder Browser

To compare two files from the Current Folder browser:

- For two files in the same folder, select the files, right-click and select **Compare Selected Files/Folders**.
- To compare files in different folders:
  - 1 Select a file, right-click and select **Compare Against**
  - 2 Select the second file to compare in the Select Files or Folders for Comparison dialog box.
  - 3 Leave the default **Comparison type**, Simulink XML text comparison.
  - 4 Click **Compare**.

If the selected files are XML or model files, the XML text comparison tool performs a Chawathe analysis and displays a report in the Comparison Tool.

For more information about comparisons of other file types (e.g., text, MAT, or binary) with the Comparison Tool, see “Comparing Files and Folders” in the MATLAB documentation.

### From the Comparison Tool

To compare files using the Comparison Tool, from the MATLAB Toolstrip, in the **File** section, select the **Compare** button. In the dialog box select files to compare.

If the selected files are XML or model files, the XML text comparison tool performs a Chawathe analysis and displays a report in the Comparison Tool.

### From a Simulink Project

If you have a Simulink Project using source control, you can create an XML comparison report from the Modified Files view of the Simulink Project Tool. For details, see “Simulink Projects”.

### From the Command Line

To compare XML files from the command line, enter

```
visdiff(filename1, filename2)
```

where `filename1` and `filename1` are XML files or Simulink models.

If the files are models, the XML comparison tool performs the comparison on the XML files. This XML comparison functionality is an extension to the MATLAB `visdiff` function. `visdiff` produces a report in the Comparison Tool

To create an `xmlcomp.Edits` object at the command line without opening the Comparison Tool, enter:

```
Edits = slxmlcomp.compare(modelname_A,modelname_B)
```

See “Export Results to the Workspace” on page 7-24 for information about the `xmlcomp.Edits` object.

## Choose a Comparison Type

If you specify two XML or model files to compare using either the Current Folder Browser or the `visdiff` function, then the Comparison Tool automatically performs the default comparison type. The defaults are XML text comparison for XML files and Simulink XML text comparison for model files.

To change comparison type, either create a new comparison from the Comparison Tool, or use the **Compare Against** option from the Current Folder browser. You can change comparison type in the Select Files or Folders for Comparison dialog box. For example, if you want the MATLAB text differences report for XML or model files, change the comparison type to Text comparison in the dialog before clicking **Compare**.

## Compare XML Files from Models with Identical Names

You can compare XML text from files of the same name. To complete the operation, the XML comparison tool copies one of the models to a temporary folder, because Simulink cannot have two models of the same name in memory at the same time. The XML comparison tool creates a read-only copy of one model named `modelname_TEMPORARY_COPY`, and compares the resulting XML files.

**Warning** When you use reverse annotation from the report, one of the models displayed is a temporary copy with a new name. The temporary copy is read-only, to avoid making changes that can be lost.

Alternatively, you can run the comparison by renaming or copying one of the files.

All *merge* operations merge from left to right, so you cannot accidentally merge to a temporary copy. Merge operations on models with identical names copy changes from the left (temporary copy) model to the right model. If you swap sides, the report always places a new temporary copy on the left side of the report, so any merges change the original model file and never a temporary copy.

If one of the models is open when you try to compare XML files, a dialog box appears where you can click **Yes** to close the file and proceed, or **No** to abort. You must close open models before the XML comparison tool can compare XML files from two models with the same name. The problem requiring you to close the loaded model is called “shadowed files”. In some cases, another model with the same name might be in memory, but not visible. See “Shadowed Files” in the Simulink documentation for more information.

If you want to automatically close open models of the same name when comparing XML files and not see the dialog box again, run these commands:

```
opt = slxmlcomp.options
opt.setCloseSameNameModel(true)
```

This is persistent across MATLAB sessions. To revert to default behavior and be prompted whether or not to close the open model every time, enter:

```
opt = slxmlcomp.options
opt.setCloseSameNameModel(false)
```

## Examples of XML Comparison

For examples with instructions, see:

- `slxml_radar_matlab_function`

- `sxml_sfcar`
- `sxml_truthtables`

For information on using and understanding the report and the XML comparison functionality, refer to “Explore the XML Comparison Report for Simulink Models” on page 7-10.

## Explore the XML Comparison Report for Simulink Models



### In this section...

- “Navigate the Simulink XML Comparison Report” on page 7-10
- “Display Items in Original Models” on page 7-14
- “Filter Out Differences” on page 7-17
- “Merge Simulink Models From the Comparison Report” on page 7-18
- “Understand the Report” on page 7-20
- “Work with Referenced Models and Library Links” on page 7-22

### Navigate the Simulink XML Comparison Report

The XML Comparison report shows changes only, not the entire XML text file contents. The report shows a hierarchical view of the portions of the two XML files that differ. The report does not show sections of the files that are identical.

To *step through differences*, use the toolbar or the **Comparison** menu. To move to the next or previous group of differences, either:

- Click the toolbar buttons Next  or Previous .
- Select **Comparison > Next** or **Comparison > Previous**. See “Step Through Changes” on page 7-13.

You can also click to select items in the hierarchical trees and observe the following display features:

- Selected items appear highlighted in a box.
- If the selected item is part of a matched pair it is highlighted in a box in both left and right trees.
- When you select an item, the original model displays and the corresponding item is highlighted. See “Display Items in Original Models” on page 7-14.



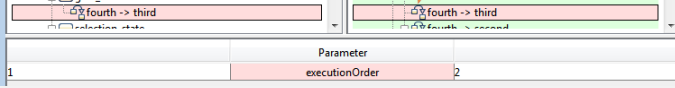
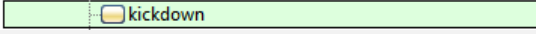
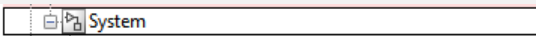

**Tip** Click a Subsystem contents node to see the report highlight all visible modified objects in the subsystem.

Report item highlighting indicates the nature of each difference as follows:

Type of report item	Highlighting	Notes
Modified	Pink	<p>Modified items are matched pairs that differ between the two files. When you select a modified item it is highlighted in a box in both trees.</p> <p>Example of a modified pair of nodes:</p>  <p>Changed parameters for the selected pair are displayed in a separate <b>Parameters</b> panel for review. If strings are too long to display in the <b>Parameters</b> table, right-click and select <b>Compare as Text</b> to open a new comparison of the parameters.</p> <p>Example of modified parameters:</p> 
Unmatched	Green	<p>When you select an unmatched item it is highlighted in a box in one tree only.</p> <p>Example of an unmatched node:</p> 
Container	None	<p>Rows with no highlighting indicate a container item that contains other modified or unmatched items.</p> <p>Example of a container node:</p> 

Icons indicate the category of item, for example: model, subsystem, Stateflow machine or chart, block, line, parameter, etc.





Use the toolbar buttons or the **Comparison** menu for the following functions:

-  **Refresh** — Run Chawathe analysis again to refresh the comparison report.
-  **Swap Sides** — Swap sides and rerun comparison. Runs the Chawathe analysis again.
-  **Next** and **Previous** — Select the next or previous group of differences. See “Step Through Changes” on page 7-13.
-  **Expand All** — Expands every item in the tree.



---

**Tip** Right-click to expand or collapse the hierarchy within the selected tree node.

---

-  **Collapse All** — Collapses all items in the tree to the most compact view possible.
-  **Printable Report** — Opens the Export Printable Report dialog box, where you can choose to save a printable version of the XML comparison report. See “Export Printable Report” on page 7-24.
-  **Filter** — Opens the Filter Current Comparison dialog box. Select check boxes to enable or disable display of categories of changes in the report. Use the filters to show only the changes you are interested in. By default the report hides all nonfunctional changes, such as repositioning of items. Turn off filters to explore *all* differences including nonfunctional changes. See “Filter Out Differences” on page 7-17.
-  **Highlight** — Enable or disable highlighting of items in original models. See “Display Items in Original Models” on page 7-14.



- 
**Merge Node** — Merge the selected node from the left side of the report to the right. See “Merge Simulink Models From the Comparison Report” on page 7-18.
- 
**Undo Merge Operations** — Revert all merge operations (also in the **Edit** menu).
- 
**Export to Workspace** — Export XML comparison results to workspace (also in the **File** menu). See “Export Results to the Workspace” on page 7-24.

If additional comparisons are available for particular nodes, you see a **Compare** button to open a report for that pair of nodes. For example, if there are differences in the Model Workspace, you can click **Compare** to open a new report to explore differences in variables.

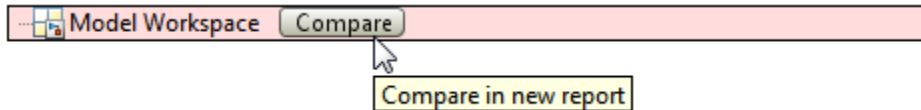

For examples with instructions, see also “Examples of XML Comparison” on page 7-8 .

## Step Through Changes

If you click **Next** repeatedly, you can step through every group of changes in the report, in the following order:

- 1 First you step through each group of changes in the left tree. When selected items have a match in the right tree then they are also highlighted.
- 2 When you reach the last item in the left tree, then **Next** steps through the remaining *unmatched* items in the right tree.
- 3 When you have stepped through all changes, **Next** returns to the beginning of the left tree.

If you click an item in the report, the **Next/Previous** controls will step through changes from the point you selected.

### Display Items in Original Models

When you compare the XML text files from Simulink models, you can choose to display the corresponding items in the original models when you select report items. You can use this *reverse annotation* function to explore the changes in the original models. When you select an item, the report invokes reverse annotation to the original model and highlights the corresponding item in the model.

---

**Tip** If you click a Subsystem contents node, the report highlights all visible modified objects in the subsystem.

---

Click a report entry to view the highlighted item (or its parent) in the model:

- If the item occurs in both models, they both appear with highlighting.
- If there is no match for the item, the unmatched report item row is green. It is considered unique and appears highlighted by itself. An appropriate system in the other model also displays to show the context of the missing item.
- If the XML comparison tool cannot highlight an item directly (e.g., configuration parameters), then it highlights the nearest ancestor of the selected node.
- If you change a block parameter value from the default, you only see the new parameter in the report. Use reverse annotation to view both blocks.
- To maximize screen space the models display with the status bar, menu bar, and model browser turned off.

The following screenshots show reverse annotation of Simulink and Stateflow items in original models using the example `sxml_sfcar`.



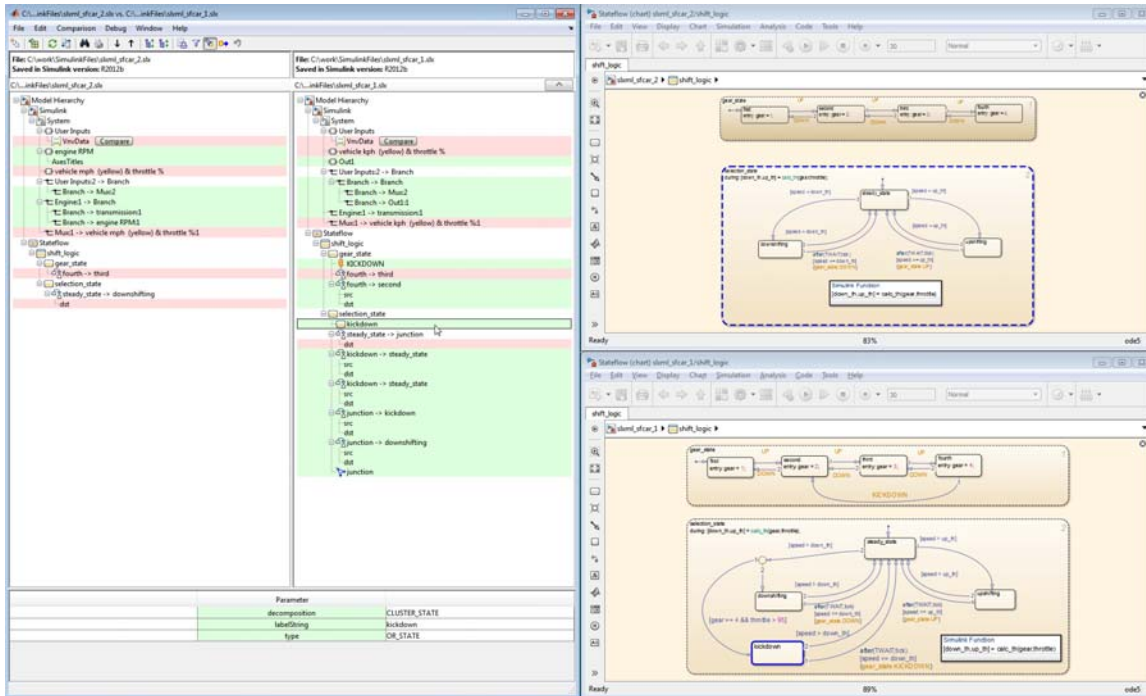

## View Changes in Model Configuration Parameters

You can use the report to explore differences in the model Configuration Parameters. If you select a Configuration Parameter item, the report displays the appropriate root node pane, if possible, of both Configuration Parameters dialog boxes.

The Parameters pane of the report displays the label text from the dialog controls (or the parameter name if it is command line only), and the parameter values. Some configuration parameters have a different hierarchy in the XML file and the dialog box. You can right-click to merge a selected parameter value in the Parameters pane.

## Control Reverse Annotation

You can toggle reverse annotation on and off by clicking the **Highlight** toolbar button in the Comparison Tool.

By default, models display to the right of the comparison report, with the model corresponding to the left side of the report on top, and the right below. If you move or resize the models your position settings are respected by subsequent reverse annotation operations within the same session. The tool remembers your window positions.

If you want to preserve window positions across sessions, position the window, and then enter:

```
slxmlcomp.storeWindowPositions
```

This preserves the placement of any Simulink windows, Stateflow windows, and truth table windows.

To stop storing window positions and return to the defaults, enter:

```
slxmlcomp.clearWindowPositions
```

## Filter Out Differences

You can use the **Filter** button or **Comparison** menu item to control display of categories of changes. Turn off filtering to view *all* identified changes. Categories for filtering include:

- **Nonfunctional changes.** The report processing identifies certain items in the XML file as nonfunctional, for example, tags representing parameters such as block, system, chart or label positions, font and color settings for blocks and lines, and system print and display settings. The report processing tries to identify “consequential” changes as nonfunctional (that is, changes as a consequence of another change). For example, if a block name changes from `block_A` to `block_B`, a line emerging from that block has a change in its source block parameter. This change in the line parameters is considered nonfunctional. Lines are highly functional, but line changes can be very noisy because of changes in blocks they connect to.
- **Line changes.** Hide all changes to signal lines including functional changes.
- **Changes in block parameter defaults.** Hiding changes in defaults can avoid duplication in the report, as any changes in blocks are also reported as functional changes where you can use reverse annotation. Block parameter defaults are an undocumented part of the Simulink XML file

that store the default parameters for the blocks used in a model. See also “Changes to Parameter Defaults Appear As New Parameters” on page 7-22.

- **Changes in the graphical interface.** This information is a summary of inports and outports at the top level of the model. Filter graphical interface changes to avoid duplication in the report, as any changes in root ports are also reported as functional changes where you can use reverse annotation.

### Exceptions

The report does *not* filter out changes to Block and System names, annotations, and Stateflow Notes as nonfunctional, even though changes to these items do not affect the outcome of simulation. The report always displays these changes to facilitate review of code changes, because they can contain important information about users’ intentions.

In certain rare cases the report filters out changes that can impact the behavior of the design. By default moves are filtered as nonfunctional, but in the following cases moves can change design behavior:

- Moving blocks can in some cases change the execution order.
- In a Stateflow chart, if you move states or junctions so that they intersect, the model fails to simulate.

To view these types of changes in the report, turn off the filter for nonfunctional changes.

### Merge Simulink Models From the Comparison Report

You can merge Simulink models from the XML text comparison report. You can merge individual parameters, blocks or entire subsystems.

The merge feature enables you to merge two versions of a design modeled in Simulink. You can merge from the left model to the right model using the XML text files. Use swap sides if necessary. You can click Undo to revert all merge operations. You can merge modified, added or deleted nodes in the report as follows:

- 1 Select a report item and click the Merge Node toolbar button , or select **Comparison > Merge Node**. Merge is disabled when you cannot merge the selected node. For example, you cannot merge the top level model nodes, data nodes, or nodes within configuration settings.

- 2 View the results in the report and the models.

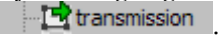
The report merges the selected node from the left side of the report to the right. Merged report nodes have gray row highlighting, and a green merge arrow if the node has an icon, e.g., .

The merge copies the change (a modified, added or deleted item) from the left model to the right model. If the node exists only in the left tree, then the merge inserts it into the right tree. Simulink Report Generator attempts to connect all lines to blocks after the merge, but you may need to manually connect some blocks.

- 3 To merge individual parameters, right-click an item in the **Parameters** pane and select **Merge Selected Parameter**.

You cannot insert or delete parameters, and not all parameters can be merged. For example, you cannot merge Simulink Identifier (SID) parameters. You can merge parameters that have changed from the default (only found on one side of the report), as long as the parameter exists in both blocks and is writable. See “Changes to Parameter Defaults Appear As New Parameters” on page 7-22.

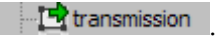
If you merge all possible parameters for a node then the report marks that node as merged, e.g., . If you partially merge some parameters of a node, the report marks the node as partially merged with a green merge arrow icon and no gray row highlighting.

- 4 (Optional) To revert all merge operations, click the Undo Merge Operations toolbar button  or select **Edit > Undo**. A dialog prompts you to confirm you want to throw away all merge operations and revert the report and models to their original state.

You will lose your merge changes if you change filter settings after any merge operations. A dialog prompts you to confirm you want to throw away

all merge operations and revert the report and models to their original state. If you click **Yes** to continue, the Chawathe analysis runs again and you see a new report with the new filtering applied.

Merging tips:

- You must merge blocks before lines in the Simulink part of the report, and in the Stateflow section you must merge states and junctions before merging transitions, or the report cannot make the connections.

For an example showing how to merge a change involving multiple nodes, see `slxml_sfcar`.

- If you want to merge subsystems, be aware that in XML text files, subsystems are represented by two nodes, the container and the contents. The two nodes have the same name but different properties, for example, name changes are a property of the container node. You can merge the container parameters and contents independently. If you want to merge a subsystem and all its properties, merge both the container and the contents nodes.
- For information on merging between models with identical names, see “Compare XML Files from Models with Identical Names” on page 7-7.

## Understand the Report

To understand the report, it is helpful to understand how the Chawathe results from the XML text files relate to the original models. Some special features of the report include:

- Hierarchical node tags (such as subsystem tags in the `.xml` file) appear twice in the tree as nested nodes. This is because the container node and the contents can have separate differences in their properties.

This feature of the XML report allows you to distinguish between property differences of the node itself, and differences contained within nodes nested inside.

- Simulink software adds new parameters when the value of that parameter differs from the default, for example, rotating a block adds a new "rotated" parameter.



- If the original models contain MATLAB Function block components, and if differences are found, the XML comparison tool lists them in the Stateflow section of the report. Click the **Compare** button at the end of the MATLAB Function block report items to open new comparisons in the Comparison Tool, showing the text difference reports for the MATLAB Function block components. See the example `s1xml_radar_matlab_function`.
- If the original models contain truth tables, and if differences are found, the XML comparison tool lists them in the Stateflow section of the report.
  - Click the **Compare** button at the end of the MATLAB Function node to see a summary of all changes.
  - Click the `truthtable` node to reverse annotate and display both `truthtable` editors.
  - Click the **Compare** button at the end of the `Condition Table` node to open a new text comparison showing only Condition differences.
  - Similarly click the **Compare** button for `Action Table` to view only Action changes.See the example `s1xml_truthtables`.

## Unexpected Results

If you see unexpected results within an XML comparison report, see “How the Matching Algorithm Works” in the MATLAB Report Generator documentation.

---

**Note** It might not be possible for the analysis to detect matches between previously corresponding sections of files that have diverged too much.

---

If you cannot see changes you expected to see in the report, click the **Filter** button to turn off filters and see *all* identified changes. See “Filter Out Differences” on page 7-17.

**Changes to Parameter Defaults Appear As New Parameters.** If you change a block parameter value from the default, you only see the new parameter in the report. Use reverse annotation to view both blocks. You see only the new parameter in the report because Simulink adds new parameters when the value of that parameter differs from the default. For example, rotating a block adds a new "rotated" parameter.

### **Work with Referenced Models and Library Links**

The XML comparison report applies only to the currently selected models, and does not include changes to any referenced models or linked libraries. For compatibility with source control and peer review workflows, the comparison report shows only changes in the files selected for comparison.

---

**Tip** If you want to examine your whole hierarchy instead, try using a Simulink Project, where you can examine modified files and dependencies across your whole project, and compare to selected revisions. See “Simulink Projects”.

---

If you are creating an XML comparison report for models that contain referenced models, and you have more than one referenced model with the same name, then your MATLAB path can affect the results. For example, this can happen if you generate an XML comparison report for the current version of your model and a previous baseline. To avoid seeing unexpected changes in model reference blocks, make sure that your referenced models are not on your MATLAB path before you generate the report.

The reason why results can change is that Simulink records information in the top model about the interface between the top model and the child model. This interface information in the top model enables incremental loading and diagnostic checks without any need to load child models.

When you load a model (for example, to compare XML) then Simulink refreshes the interface information for referenced models if it can find the child model. Simulink can locate the child model if it is on the path. If another model of the same name is higher on the path, Simulink updates the interface information for that other model before comparing XML. This can produce entries for model reference blocks in the comparison report that you did not

expect. If you make sure your referenced models are not on your path before you generate the report, then you can avoid these unexpected results. If both model versions are off the path, the interface information in the top model is not refreshed during the XML comparison process. Instead the cached information is used, resulting in a valid XML comparison report.

With library links, Simulink does not update the cached interface information when comparing XML, and so the report correctly captures library interfaces. However with both referenced models and library links, Simulink updates the information when displaying the model. When displaying report items in original models, you may see unexpected results because Simulink may find a model or library that is higher in the path. To obtain the clearest results, make sure that the models and associated libraries are temporarily removed from the path. By removing the files from the path you will see unresolved library links and referenced models when you view the original models, but their interfaces will be correct and will correctly align with the comparison report.

## Export, Print, and Save XML Comparison Results

### In this section...

“Export Printable Report” on page 7-24

“Export Results to the Workspace” on page 7-24

“Save Comparison Log Files in a Zip File” on page 7-26

### Export Printable Report

To save a printable version of an XML comparison report,

- 1 Select **Comparison > Printable Report** or click the  toolbar button.

The Export Printable Report dialog box opens.

- 2 Select a file name and location to save the report.

The report is a noninteractive HTML document of the differences detected by the Chawathe algorithm for printing, sharing, or archiving a record of the comparison. If you have applied filters, your filtered results appear in the printable report.

### Export Results to the Workspace

To export the XML comparison results to the MATLAB base workspace,

click the toolbar button  **Export to Workspace**, or select **File > Export to Workspace**. Specify a name for the export object in the dialog and click **OK**. This action exports the results of the XML comparison to an `xmlcomp.Edits` object in the workspace. The `xmlcomp.Edits` object contains information about the XML comparison including file names, filters applied, and hierarchical nodes that differ between the two XML files.

To create an `xmlcomp.Edits` object at the command line without opening the Comparison Tool, enter:

```
Edits = slxmlcomp.compare(modelname_A,modelname_B)
```

<b>Property of xmlcomp.Edits</b>	<b>Description</b>
Filters	Array of filter structure arrays. Each structure has two fields, Name and Value.
LeftFileName	File name of left model exported to XML.
LeftRoot	xmlcomp.Node object that references the root of the left tree.
RightFileName	File name of right model exported to XML.
RightRoot	xmlcomp.Node object that references the root of the right tree.
TimeSaved	Time when results exported to the workspace.
Version	MathWorks release-specific version number of xmlcomp.Edits object.

<b>Property of xmlcomp.Node</b>	<b>Description</b>
Children	Array of xmlcomp.Node references to child nodes, if any.
Edited	Boolean — If Edited = true then the node is either inserted (green) or part of a modified matched pair (pink).
Name	Name of node.
Parameters	Array of parameter structure arrays. Each structure has two fields, Name and Value.

Property of <code>xmlcomp.Node</code>	Description
Parent	<code>xmlcomp.Node</code> reference to parent node, if any.
Partner	If matched, Partner is an <code>xmlcomp.Node</code> reference to the matched partner node in the other tree. Otherwise empty [].

## Save Comparison Log Files in a Zip File

Temporary comparison files accumulate in `tempdir/MatlabComparisons/XMLComparisons/TempDirs/`. These temporary files are deleted when you close the related comparison report.

You can zip the temporary files (such as log files) created during XML text comparisons for sharing or archiving. While the comparison report is open, enter:

```
xmlcomp.zipTempFiles('c:\work\myexportfolder')
```

The destination folder must exist. The output reports the zip file name:

```
Created the zipfile "c:\work\myexportfolder\20080915T065514w.zip"
```

To view the log file for the last comparison in the MATLAB Editor, enter:

```
xmlcomp.showLogFile
```

## Compare XML from Models Managed with Subversion

### In this section...

“Work with Subversion” on page 7-27

“Create file\_comparison\_driver Function” on page 7-28

“Configure TortoiseSVN” on page 7-28

“Test TortoiseSVN Setup” on page 7-30

“Example file\_comparison\_driver Code” on page 7-31

### Work with Subversion

Simulink Projects provide built-in Subversion source control integration. You can create an XML comparison report from the Modified Files view of the Simulink Project Tool. See “Simulink Projects”.

Alternatively, you can customize your external Configuration Management tools to call the XML comparison functionality in the Simulink Report Generator, as described on this page.

Comparing two versions of the same file is a common workflow when using Configuration Management tools. If your Configuration Management tool is configurable, you can customize your *Diff* operations on Simulink model files from your Configuration Management tool to call the XML comparison functionality in the Simulink Report Generator. This allows you to compare two versions of the XML from the same model file and generate a report of the differences.

TortoiseSVN and Subversion are a popular suite of open-source version control tools. The following example describes how to configure TortoiseSVN to use the Simulink Report Generator XML comparison. You can register the XML comparison function with TortoiseSVN as an extension-specific diff program to use for model files. When you perform a TortoiseSVN diff on a model file, TortoiseSVN uses the XML comparison to generate a report. This workflow describes a typical usage of Subversion on a Windows® PC.

There are two steps:

- Create and save a MATLAB function `file_comparison_driver` that opens the Comparison Tool and invokes the XML comparison function for model files. For an example, see “Example `file_comparison_driver` Code” on page 7-31.
- Configure TortoiseSVN to use the `file_comparison_driver` function for model files.

Optionally, you can also configure TortoiseSVN to use the same function to call the MATLAB Comparison Tool for `.mat` files and for Simulink manifest files (`.smf` files).

### Create `file_comparison_driver` Function

Create and save a MATLAB function that invokes the Comparison Tool as follows:

- 1 Use the example code to create your file comparison function. Copy the code in the section “Example `file_comparison_driver` Code” on page 7-31 into a new file in the MATLAB Editor.
- 2 Save the file as `file_comparison_driver.m`.
- 3 Make sure the file is on the MATLAB path.
- 4 Test your function by calling it within MATLAB with two model files. For example:

```
file_comparison_driver( which('f14'),which('f14c') )
```

### Configure TortoiseSVN

This example is compatible with Release 2008b+ onwards and was tested with Subversion 1.6.2 on Windows XP.

Configure TortoiseSVN to use the XML comparison tool for model files, as follows:

- 1 Right-click a file in Windows Explorer and select **TortoiseSVN > Settings**.
- 2 In the TortoiseSVN Settings dialog box, click **Diff Viewer** under **External Programs** in the tree, then click the **Advanced** button.



- 3** In the Advanced Diff settings dialog box, add an entry to specify what to do with model files.
  - a** Click **Add**.
  - b** In the Add extension specific diff program dialog box, enter `.mdl` or `.slx` for the **Extension** and enter the following command in the **External Program** edit box:

```
"matlabroot\bin\matlab.exe" -r  
file_comparison_driver("%base%", "%mine%") -nosplash
```

Replace *matlabroot* with the path to the specific location on your computer for your MATLAB installation, for example, `C:\Program files\MATLAB\R2009a`.

The following example shows this setup on an Release 2009a installation.

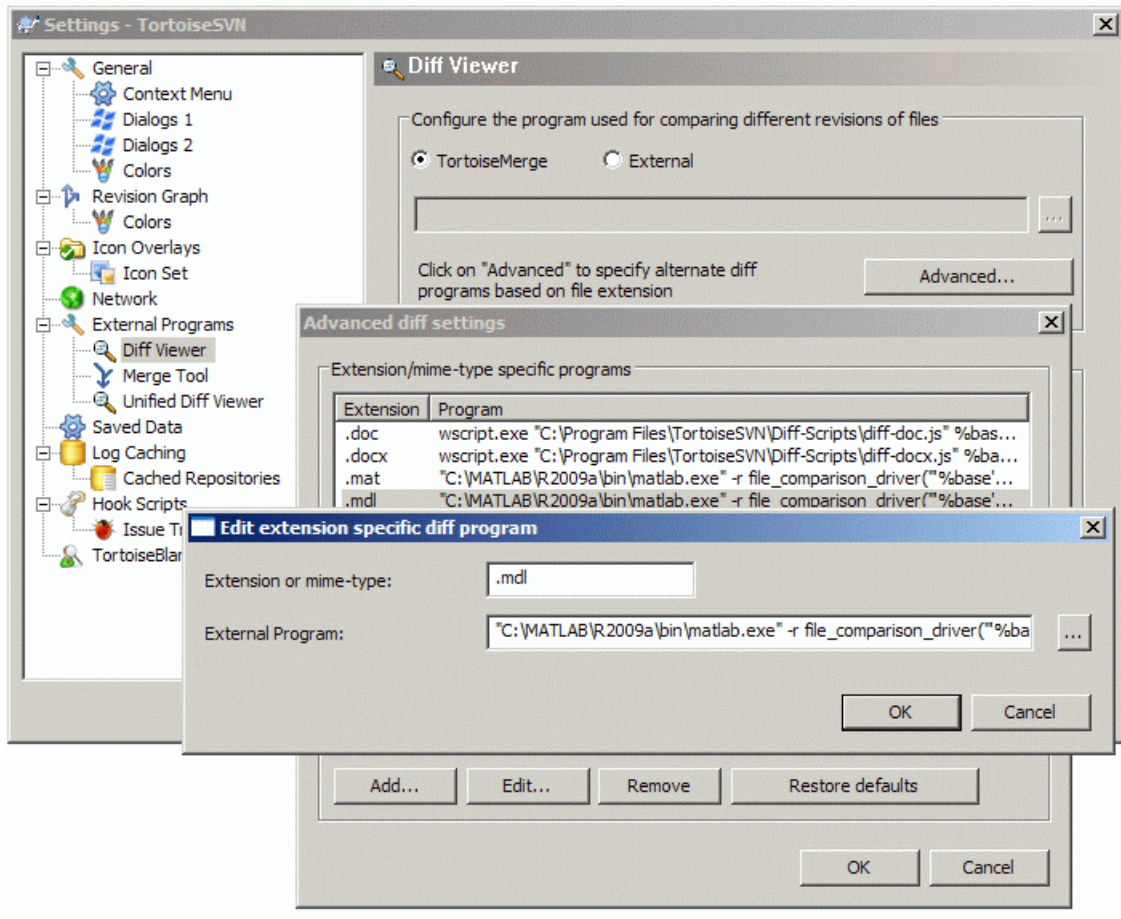

**4** Click **OK** to apply your changes and close all the Tortoise SVN dialog boxes.

**5** If you also want to use the MATLAB Comparison Tool for `.mat` files and for Simulink manifest files (`.smf` files) you can repeat the steps to add exactly the same **External Program** command for `.mat` files and `.smf` files.

### Test TortoiseSVN Setup

To test your setup, follow these steps:

- 1 Start MATLAB and open, modify, and save a Simulink model that is managed in a Subversion archive. This creates a local working copy that is different to the head repository copy.
- 2 In Windows Explorer, right-click your modified file, and select **TortoiseSVN > Diff**.

TortoiseSVN runs a new instance of MATLAB. MATLAB loads and runs the `file_comparison_driver.m` file. The `file_comparison_driver` function performs these steps:

- 1 Creates temporary copies of the current working version of the Simulink model and the previously stored version of the model.
- 2 Compares the XML text files from both models and generates a comparison report displayed in the MATLAB Comparison Tool.

The function must preprocess the file names by creating renamed temporary copies because Subversion uses a temporary file naming convention that is not compatible with Simulink because of invalid delimiting characters. The branch and version information is embedded in the temporary model names. See also “Compare XML Files from Models with Identical Names” on page 7-7 for information about using the report and a warning to avoid losing work in the temporary models.

Other TortoiseSVN workflows using Diff operations are also supported, such as comparing two versions in an archive.

## Example `file_comparison_driver` Code

Use the following example code to create your file comparison function, as described in “Create `file_comparison_driver` Function” on page 7-28.

```
function file_comparison_driver(base, mine)
%FILE_COMPARISON_DRIVER
%
%
% Use this function to call the MATLAB Comparison Tool
% from external tools such as the diff
% function of Subversion.
```

```
% If you have Simulink Report Generator version 3.5 or later
% installed, then the XML Comparison feature is called if you
% use this function with model files.
%
% Typical use:
% "c:\matlab\R2009a\bin\matlab.exe" -r file_comparison_driver
%     ("%base%", "%mine%") -nosplash
%
% This example is compatible with Release 2008b+ onwards and
% was tested with Subversion 1.6.2 on Windows XP Professional.

% Copyright 2008-2012 The MathWorks, Inc.

% Confirm inputs:
error(nargchk(2, 2, nargin, 'struct'))

% Uncomment the following line if using a release before R2009b.
% slxmlcomp.register;

% Create a new temporary folder:
new_folder = tempname;
mkdir(new_folder)

% Create a temporary copy of the base file that uses a
% valid MATLAB file name:
new_base = create_temp_locations(base, new_folder);
new_mine = create_temp_locations(mine, new_folder);

% Use "visdiff" function to open MATLAB Comparison Tool:
visdiff(new_base, new_mine)

end

% -----
function new = create_temp_locations(old, new_dir)
% Names may have unsupported characters due to Subversion
% conventions. Change them to underscores.
[~, old_name, ext] = fileparts(old);
new_name = replace_unsupported_characters(old_name);
```

```
% If no characters needed replacing then there is no
% need to create a temporary copy
if strcmp(old_name,new_name)
    new = old;
    return
end

% Create new target location for this file:
new = fullfile(new_dir, [new_name ext]);

% Copy files to the temporary location:
ok = copyfile(old, new, 'f');
assert(ok, 'Failed to copy files to temporary location');
end

% -----
function new = replace_unsupported_characters(old)
firstLetterIndex = regexp(old, '[a-z_A-Z]', 'start', 'once');
new = old(firstLetterIndex:end);
new = strrep(new, '.', '_');
new = strrep(new, '-', '_');
end
```



# Component Reference

---

Simulink Coder Components (p. 8-2)	Report on code generated by Simulink Coder software
Requirements Management Interface Components (p. 8-3)	Report block requirements data
Simulink Components (p. 8-4)	Report on Simulink models
Simulink Blocks Components (p. 8-7)	Report on specified Simulink block types
Simulink® Fixed Point™ Components (p. 8-8)	Report on Simulink Fixed Point blocks
Stateflow Components (p. 8-9)	Report on Stateflow models

This chapter describes Simulink Report Generator components. For information about MATLAB Report Generator components, see the MATLAB Report Generator documentation.

## **Simulink Coder Components**

Code Generation Summary

Insert version number information, list of generated files, tables summarizing code generation configuration information, and subsystem maps into report

Import Generated Code

Import source and header files generated by Simulink Coder software, and custom files specified as part of model



## Requirements Management Interface Components

Missing Requirements Block Loop	Apply all child components to blocks that do not have requirements
Missing Requirements System Loop	Loop only on systems and subsystems that do not have associated requirements
Requirements Block Loop	Apply child components to blocks with requirements
Requirements Documents Table	Insert table of linked requirements documents
Requirements Signal Loop	Apply all child components to signal groups with requirements
Requirements Summary Table	Properties of blocks, systems, or Stateflow objects with associated requirements
Requirements System Loop	Apply child components to systems with requirements
Requirements Table	Requirements links for current context

## Simulink Components

Annotation Loop	Run child components multiple times for each Simulink annotation in current context
Block Execution Order List	Create a list or table of all nonvirtual blocks in the model, showing order in which they execute
Block Loop	Run child components for each block in the current system, model, or signal
Block Type Count	Count number of each block type in the current model or system
MATLAB Function	Insert information about MATLAB Function block contents
Model Advisor Report	Insert Model Advisor report or link to Model Advisor report for current model
Model Change Log	Construct model history table that displays model revision information
Model Configuration Set	Insert active configuration set of a model into a report
Model Loop	Loop on Simulink models and systems, as specified by child components
Model Simulation	Run current model with specified simulation parameters
Signal Loop	Run child components for each signal contained in current system, model, or block
Simulink Automatic Table	Insert two-column table with information on selected model, system, signal, or block

Simulink Dialog Snapshot	Insert snapshots of Simulink editor dialog boxes
Simulink Functions and Variables	Create table that displays workspace variables and MATLAB functions used by reported blocks in Simulink models
Simulink Library Information	Insert table that lists library links in the current model, system, or block
Simulink Linking Anchor	Designate locations to which links point
Simulink Name	Insert name of a Simulink model, system, block, or signal into report
Simulink Property	Insert property name/property value pair for current Simulink model, system, block, or signal
Simulink Property Table	Insert table that reports on model-level property name/property value pairs
Simulink Sample Time	Insert title of Simulink sample time into report
Simulink Summary Table	Properties or parameters of specified Simulink models, systems, blocks, or signals in table
Simulink Workspace Variable	Report information about MATLAB and model workspace variables that model uses
Simulink Workspace Variable Loop	Reports on Simulink workspace variable objects
System Filter	Run child components if current system meets specified conditions
System Hierarchy	Create nested list that shows hierarchy of specified system

System Loop	Specify systems and subsystems on which to loop, as defined by parent component
System Snapshot	Insert snapshot of the current system into report
To Workspace Plot	Capture plot figure created in the MATLAB workspace

## Simulink Blocks Components

Bus

Create list of signals exiting from  
Bus Selector block

Documentation

Insert text extracted from DocBlock  
blocks in Simulink models

Look-Up Table

Report on lookup table blocks

Scope Snapshot

Insert images of Simulink scopes  
and XY graphs

## **Simulink Fixed Point Components**

Fixed Point Block Loop	Run child components for the Simulink model, system, or signal defined by parent component
Fixed Point Logging Options	Set fixed-point options like in Fixed Point Tool
Fixed Point Property Table	Insert table that reports on Simulink Fixed Point block property name/property value pairs
Fixed Point Summary Table	Table of specified fixed-point block properties or parameters

## Stateflow Components

Chart Loop	Run child components for specified Stateflow charts
Machine Loop	Run child components for specified Stateflow machines
Object Loop	Run child components for Stateflow objects, and then insert table into report
Simulink Function System Loop	Report on Simulink functions specified in a Stateflow loop
State Loop	Run child components for all states in current context
Stateflow Automatic Table	Insert table with properties of current Stateflow object
Stateflow Count	Count number of Stateflow objects in current context
Stateflow Dialog Snapshot	Insert snapshots of Stateflow editor dialog boxes
Stateflow Filter	Run child components only if current object type matches specified object type
Stateflow Hierarchy	Provide visual representation of the hierarchy of a Stateflow object
Stateflow Hierarchy Loop	Run child components on Stateflow object hierarchy
Stateflow Linking Anchor	Designate locations to which links point
Stateflow Name	Insert into report name of Stateflow object specified by parent component
Stateflow Property	Insert into report table, text, or paragraph with information on selected Stateflow object property

Stateflow Property Table	Insert into report property-value table for Stateflow object
Stateflow Snapshot	Insert into report snapshot of Stateflow object
Stateflow Summary Table	Table of properties or parameters of specified Stateflow object
Truth Table	Report on truth tables in Simulink and Stateflow models



# Components — Alphabetical List

---

For a list of MATLAB Report Generator components, see the MATLAB Report Generator documentation.

- Annotation Loop
- Block Execution Order List
- Block Loop
- Block Type Count
- Bus
- Chart Loop
- Code Generation Summary
- Documentation
- Fixed Point Block Loop
- Fixed Point Logging Options
- Fixed Point Property Table
- Fixed Point Summary Table
- Import Generated Code
- Look-Up Table
- Machine Loop
- Missing Requirements Block Loop
- MATLAB Function
- Missing Requirements System Loop
- Model Advisor Report
- Model Change Log
- Model Configuration Set
- Model Loop
- Model Simulation

Object Loop  
Requirements Block Loop  
Requirements Documents Table  
Requirements Signal Loop  
Requirements Summary Table  
Requirements System Loop  
Requirements Table  
Scope Snapshot  
Signal Loop  
Simulink Automatic Table  
Simulink Dialog Snapshot  
Simulink Function System Loop  
Simulink Functions and Variables  
Simulink Library Information  
Simulink Linking Anchor  
Simulink Name  
Simulink Property  
Simulink Property Table  
Simulink Sample Time  
Simulink Summary Table  
Simulink Workspace Variable  
Simulink Workspace Variable Loop  
State Loop  
Stateflow Automatic Table  
Stateflow Count  
Stateflow Dialog Snapshot  
Stateflow Filter  
Stateflow Hierarchy  
Stateflow Hierarchy Loop  
Stateflow Linking Anchor  
Stateflow Name  
Stateflow Property  
Stateflow Property Table  
Stateflow Snapshot  
Stateflow Summary Table  
System Filter  
System Hierarchy

---

System Loop  
System Snapshot  
To Workspace Plot  
Truth Table

# Annotation Loop

---

**Purpose** Run child components multiple times for each Simulink annotation in current context

**Description** This component runs its child components multiple times for each Simulink annotation in the current context. The parent component determines the context.

- **Model Loop:** Reports on all annotations inside the reported portion of the reported model.
- **System Loop:** Reports on all annotations inside the current system.
- **Block Loop or Signal Loop:** Does nothing.

**Loop Options** The Loop Options pane displays information about the current context. You can sort `Alphabetically` by `text` or `In traversal order`.

Child components of the `Annotation Loop` consider their context to be annotations when the report is running.

For example, the following components report on the looped annotation:

- `Simulink Automatic Table`
- `Simulink Linking Anchor`
- `Simulink Name`
- `Simulink Property`
- `Simulink Property Table`

Use a `Summary Table` component to show annotation objects in reports. Each `Summary Table` component creates a single table with each reported annotation on a single row of the table.

**Section Options**

- **Create section for each object in loop:** Inserts a section in the generated report for each object found in the loop.
- **Display the object type in the section title:** Inserts the object type automatically into the section title in the generated report.

- **Create link anchor for each object in loop:** Creates a hyperlink to each object in the loop, the generated report.

## See Also

Block Loop, Model Loop, Signal Loop, System Loop, Simulink Linking Anchor, Simulink Name, Simulink Property, Simulink Property Table, Simulink Summary Table

# Block Execution Order List

---

<b>Purpose</b>	Create a list or table of all nonvirtual blocks in the model, showing order in which they execute
<b>Description</b>	<p>This component creates a list or table of all nonvirtual blocks in the model, showing the order in which they execute.</p> <p>For more information about virtual and nonvirtual blocks, see “About Blocks” in the Simulink documentation.</p>
<b>Properties</b>	<ul style="list-style-type: none"><li>• <b>List Title:</b><ul style="list-style-type: none"><li>▪ Automatic: Generates a list or table title automatically.</li><li>▪ Custom: Enables you to enter a title.</li></ul></li><li>• <b>Include block type information:</b> Include each block’s BlockType property in the list or table.</li><li>• <b>Look under nonvirtual subsystems:</b> The default is Automatic (On for models, Off for systems). Set it to On or Off.</li></ul>
<b>Insert Anything into Report?</b>	Yes. List.
<b>Class</b>	rptgen_sl.csl_blk_sort_list
<b>See Also</b>	Block Loop

- Purpose** Run child components for each block in the current system, model, or signal
- Description** This component runs its child components for each block contained in the current system, model, or signal.
- For more information on working with looping components, see “Dynamic Reporting Components” on page 6-22.
- Report On** This pane describes the type of object on which this component operates.
- **Automatic list from context:** Report on all blocks in the current context. The parent component of the Block Loop determines its context. If this component does not have the **Model Loop**, **System Loop**, **Signal Loop**, or **Block Loop** as its parent, selecting this option causes this component to report on all blocks in all models.
    - **Model Loop:** Reports on all blocks in the current model.
    - **System Loop:** Reports on all blocks in the current system.
    - **Signal Loop:** Reports on all blocks connected to the current signal.
  - **Custom - use block list:** Enables you to specify a list of blocks on which to report. Enter the full path of each block.

## Loop Options

Choose block sorting options and reporting options in this pane.

- **Sort blocks:**

Use this option to select how to sort blocks (applied to each level in a model):

  - **Alphabetically by block name.** Sorts blocks alphabetically by their names.
  - **Alphabetically by system name.** Sorts systems alphabetically. The report lists blocks in each system, but in no particular order.
  - **Alphabetically by full Simulink path.** Sorts blocks alphabetically by Simulink path.

# Block Loop

---

- By block type. Sorts blocks alphabetically by block type.
- By block depth. Sorts blocks by their depth in the model.
- By layout (left to right): Sorts blocks by their location in the model layout, by *rows*. The block appearing the furthest toward the left top corner of the model is the anchor for the row. The row contains all other blocks that overlap the horizontal area defined by the top and bottom edges of the anchor block. The other rows use the same algorithm, using as the anchor the next unreported block nearest the left top of the model.

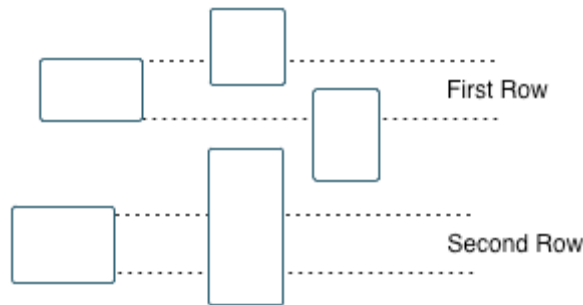

- By layout (top to bottom): Sorts blocks by their location in the model layout, by *columns*. The block appearing the furthest toward the left top corner of the model is the anchor for the column. The column contains all other blocks that overlap the vertical area defined by the left and right edges of the anchor block. The other columns use the same algorithm, using as the anchor the next unreported block nearest the left top of the model.
- By traversal order. Sorts blocks by traversal order.
- By simulation order. Sorts blocks by execution order.
- `%<VariableName>`: Inserts the value of a variable from the MATLAB workspace. The `%<>` notation can denote a string or cell array. The following example reports on the `theta dot` integrator



block and the `theta` integrator block in the model `simppend`, using the variable `Z={ 'simppend/theta' }`:

```
simppend/theta dot
%<Z>
```

The generated report includes information about the following blocks:

- `simppend/theta dot`
- `simppend/theta`

For more information, see `%<VariableName> Notation` on the `Text` component reference page in the MATLAB Report Generator documentation.

- **Search for Simulink property name/property value pairs:** Reports only on Simulink blocks with specified property name/property value pairs.

## Section Options

- **Create section for each object in loop:** Inserts a section in the generated report for each block found in the loop.
- **Display the object type in the section title:** Automatically inserts the object type into the section title in the generated report.
- **Create link anchor for each object in loop:** Create a hyperlink to the block in the generated report.

## Insert Anything into Report?

Yes, inserts a section if you select the **Create section for each object in loop** option.

## Class

`rptgen_sl.csl_blk_loop`

# Block Loop

---

## **See Also**

Model Loop, Signal Loop, System Loop, Simulink Linking Anchor, Simulink Name, Simulink Property, Simulink Property Table, Simulink Summary Table

<b>Purpose</b>	Count number of each block type in the current model or system
<b>Description</b>	<p>This component counts the number of each block type in the current model or system. Within a model, this component counts blocks underneath masks and inside library links.</p> <p>For more information about block types, see “About Blocks” in the Simulink documentation.</p>
<b>Count Types</b>	<p>The parent of this component determines where to count block types:</p> <ul style="list-style-type: none"><li>• <b>Model Loop:</b> Reports all block types in the current model:<ul style="list-style-type: none"><li>▪ <b>All blocks in model:</b> Counts block types in the entire model.</li><li>▪ <b>All blocks in reported systems:</b> Counts block types only in systems that appear in the report.</li></ul></li><li>• <b>System Loop:</b> Reports all block types in the current system.</li></ul>
<b>Table Content</b>	<ul style="list-style-type: none"><li>• <b>Table title:</b> Allows you to enter the table title.</li><li>• <b>Show block names in table:</b> Includes a column that displays all block names in the table.</li><li>• <b>Sort table:</b><ul style="list-style-type: none"><li>▪ <b>Alphabetically by block type:</b> Sorts blocks alphabetically by block type.</li><li>▪ <b>By number of blocks:</b> Sorts by decreasing number of occurrences.</li></ul></li><li>• <b>Show total count:</b> Displays total number of block types.</li></ul>
<b>Insert Anything into Report?</b>	Yes. Table.
<b>Class</b>	rptgen_sl.csl_blk_count

# Block Type Count

---

## **See Also**

Block Loop, Model Loop, System Loop

**Purpose**

Create list of signals exiting from Bus Selector block

**Description**

This component creates a list of signals exiting a Bus Selector block. The list contains signals leaving from the reported block or downstream buses and signals.

The parent of this component determines which buses appear in the report:

- **Model Loop:** Includes all buses in the current model.
- **System Loop:** Includes all buses in the current system.
- **Block Loop :** If the current block is a bus block, then the report includes that block.
- **Signal Loop:** Includes all buses connected to the current signal.

If the Bus component does not have a looping component as its parent, it reports on all buses in all open models.

**Properties**

- **Show Bus Hierarchy:** Specifies whether the list displays downstream buses hierarchically.
- **Insert linking anchor for bus blocks:** Inserts a linking anchor for each bus block. This property designates the list item as the location to which other links for that block point. (For more information, see the Simulink Linking Anchor or Link component reference pages.) Do not use this option if you have already specified an anchor location for the bus block with an Object Linking Anchor component.
- **Insert linking anchor for signals:** Inserts a linking anchor for each signal. This property designates the list item as the location to which other links for that signal point. For more information, see the Simulink Linking Anchor or Link component reference pages.) Do not use this option if you have already specified an anchor location for the signal with an Object Linking Anchor component.
- **Title:** Inserts a title before each list. This attribute supports the %<varname> notation. For more information, see %<VariableName>

# Bus

---

Notation on the Text component reference page in the MATLAB Report Generator documentation.

## **Insert Anything into Report?**

Yes. List.

## **Class**

rptgen\_sl.csl\_blk\_bus

## **See Also**

Block Loop, Model Loop, Signal Loop, Simulink Linking Anchor, System Loop,

**Purpose**

Run child components for specified Stateflow charts

**Description**

This component runs its children for specified Stateflow charts.

**Report On**

- **Automatic list from context:** Report on all chart blocks in the context set by the parent of this component.
  - **Model Loop:** Reports on all Stateflow chart blocks in the current model.
  - **System Loop:** Reports on all Stateflow chart blocks in the current system.
  - **Signal Loop:** Reports on all Stateflow chart blocks connected to the current signal.
  - **Machine Loop:** Reports on the current block if it is in a Stateflow chart.

If the Chart Loop component has any other type of component as its parent, selecting this option causes it to report on all Stateflow chart blocks.

- **Custom - use block list:** Reports on a specified list of Stateflow chart blocks.

**Loop Options**

Choose chart block sorting options and reporting options in this pane.

- **Sort blocks:** Specifies how to sort blocks (applied to each level in a model). This option is available if you select **Automatic list from context** in the **Report On** section, or if you select **Custom - use block list** and the **Sort blocks** option.
  - **Alphabetically by block name.** Sorts blocks alphabetically by name.
  - **Alphabetically by system name.** Sorts systems alphabetically by name. Lists blocks in each system, but in no particular order.
  - **Alphabetically by full Simulink path.** Sorts models alphabetically by their full paths.

# Chart Loop

---

- By block type. Sorts blocks alphabetically by block type.
- By depth. Sorts blocks by their depth in the model.
- By layout (left to right): Sorts blocks by their location in the model layout, by *rows*. The block appearing the furthest toward the left top corner of the model is the anchor for the row. The row contains all other blocks that overlap the horizontal area defined by the top and bottom edges of the anchor block. The other rows use the same algorithm, using as the anchor the next unreported block nearest the left top of the model.

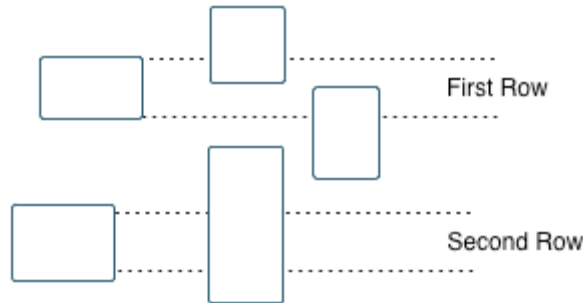

- By layout (top to bottom): Sorts blocks by their location in the model layout, by *columns*. The block appearing the furthest toward the left top corner of the model is the anchor for the column. The column contains all other blocks that overlap the vertical area defined by the left and right edges of the anchor block. The other columns use the same algorithm, using as the anchor the next unreported block nearest the left top of the model.
- By simulation order. Sorts blocks by execution order.
- `%<VariableName>`: Inserts the value of a variable from the MATLAB workspace. The `%<>` notation can denote a string or cell array. For more information, see `%<VariableName> Notation` on the Text component reference page in the MATLAB Report Generator documentation.



- **Search for Simulink property name/property value pairs:** Reports on Simulink blocks with specified property name/property value pairs.
- **Search Stateflow:** Reports on Stateflow charts with specified property name/property value pairs.

## Section Options

- **Create section for each object in loop:** Inserts a section in the generated report for each object found in the loop.
- **Display the object type in the section title:** Inserts the object type automatically into the section title in the generated report.
- **Create link anchor for each object in loop:** Creates a hyperlink to the object in the generated report

## Insert Anything into Report?

Yes, inserts a section if you select the **Create section for each object in loop** option.

## Class

rptgen\_sf.csf\_chart\_loop

## See Also

Block Loop, Machine Loop, Model Loop, Signal Loop, System Loop, Simulink Function System Loop

# Code Generation Summary

---

**Purpose** Insert version number information, list of generated files, tables summarizing code generation configuration information, and subsystem maps into report

**Description** This component reports the following information:

- Version number information
- List of generated files
- Code generation configuration information
- Subsystem map

**Summary**

- **General information:** Includes the following information in the report:
  - Model name and version
  - Simulink Coder version number
  - List of full paths of generated files
- **Configuration settings:** Includes tables that list optimization and Simulink Coder target selection and build process Configuration Parameter settings.
- **Subsystem map:** Includes in the report a unique mapping between subsystem numbers and subsystem labels in the model.

**Traceability Report** Use **settings from model:** When you select this option, the report uses all of the following configuration settings, as specified in your model. Deselecting this option allows you to turn off one or more of these settings as needed:

- **Eliminated/virtual blocks**
- **Traceable blocks**
- **Traceable StateFlow Objects**
- **Traceable MATLAB Function Blocks**

For more information on these configuration settings, see “Code Generation Pane: Report” in the Simulink Coder documentation.

**Insert  
Anything  
into  
Report?**

Yes. Tables and list.

**Class**

RptgenRTW.CCodeGenSummary

**See Also**

Import Generated Code

# Documentation

---

**Purpose** Insert text extracted from DocBlock blocks in Simulink models

**Description** This component inserts text extracted from DocBlock blocks in Simulink models. It can have the following components as its parent:

- Model Loop
- System Loop
- Block Loop

The specified report format determines the format of the DocBlock block data inserted into the report:

- HTML: Imports HTML data into the report.

---

**Note** For non-English HTML DocBlock text that you want to include in a Documentation component, use UTF-8 file encoding. Use a simple text editor to create the HTML code.

---

- RTF: Imports RTF data into the report.

**Properties**

- **Import file as:** Specifies how to format the imported information. The following example shows how each option works, using the following text as input:

First row.  
Second row.

Third row follows blank line.

- Plain text (ignore line breaks). Imports plain text without any line breaks (no paragraphs), as in this example:

First row. Second row. Third row follows blank line.

- Paragraphs defined by line breaks. Imports the text contained in paragraphs defined by line breaks (hard returns or carriage returns), as in this example:

First row.  
Second row.

Third row follows blank line.

- Paragraphs defined by empty rows. Imports text contained in paragraphs defined by empty rows (rows that do not contain text), as in this example:

First row. Second row.

Third row follows blank line.

- Text (retain line breaks). Imports plain text, including line breaks, as in this example:

First row.  
Second row.

Third row follows blank line.

- Fixed-width text (retain line breaks). Imports fixed-width text (all letters have the same width or size) including line breaks, as in this example:

First row.  
    Second row.

Third row follows blank line.

---

**Tip** This option is useful for importing MATLAB files.

---

- **Insert linking anchor for blocks:** Inserts a linking anchor for each DocBlock block that designates the location where other links for that block point. (See the [Simulink Linking Anchor](#) or [Link](#) component reference pages for more help.) Do not use this option if you have already specified an anchor location for a DocBlock block with an [Object Linking Anchor](#) component.

**Insert  
Anything  
into  
Report?**

Yes. Text, paragraph, or external RTF/HTML data.

**Class**

rptgen\_sl.cs1\_blk\_doc

**See Also**

[Block Loop](#), [Model Loop](#), [Simulink Linking Anchor](#), [System Loop](#)

**Purpose** Run child components for the Simulink model, system, or signal defined by parent component

**Description** This component runs its children for the Simulink model, system, or signal that its parent defines. Options for the parent component are:

- Model Loop
- System Loop
- Signal Loop

**Report On**

- **Automatic list from context:** Reports on all fixed-point blocks in the context of the parent of this component. For example, if the parent component is the **System Loop**, then this component reports on all fixed-point blocks in the current system. If this component does not have a looping component as its parent, then selecting this option causes the component to report on all fixed-point blocks in all models.
- **Custom - use block list::** Reports on a specified list of blocks.

## Loop Options

Choose block sorting options and reporting options in this pane.

- **Sort blocks:** Specifies how to sort blocks (applied to each level in a model). This option is available if you select the **Automatic list from context** option in the **Report On** section, or if you select **Custom - use block list** and the **Sort blocks** options.
  - **Alphabetically by block name.** Sorts blocks alphabetically by name.
  - **Alphabetically by system name.** Sorts systems alphabetically. Lists blocks in each system, but in no particular order.
  - **Alphabetically by full Simulink path.** Sorts blocks alphabetically by Simulink path.
  - **By block type.** Sorts blocks alphabetically by block type.
  - **By block depth.** Sorts blocks by their depth in the model.

# Fixed Point Block Loop

---

- By layout (left to right): Sorts blocks by their location in the model layout, by *rows*. The block appearing the furthest toward the left top corner of the model is the anchor for the row. The row contains all other blocks that overlap the horizontal area defined by the top and bottom edges of the anchor block. The other rows use the same algorithm, using as the anchor the next unreported block nearest the left top of the model.

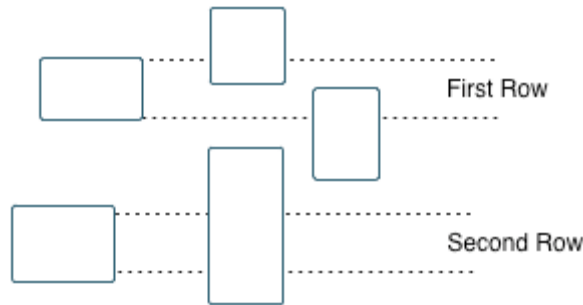

- By layout (top to bottom): Sorts blocks by their location in the model layout, by *columns*. The block appearing the furthest toward the left top corner of the model is the anchor for the column. The column contains all other blocks that overlap the vertical area defined by the left and right edges of the anchor block. The other columns use the same algorithm, using as the anchor the next unreported block nearest the left top of the model.
- By traversal order. Sorts blocks by traversal order.
- By simulation order. Sorts blocks by execution order.
- `%<VariableName>`: Inserts the value of a variable from the MATLAB workspace. For more information, see `%<VariableName>` Notation on the Text component reference page in the MATLAB Report Generator documentation.
- **Search for Simulink name/property value pairs**: Reports only on blocks with the specified property name/property value pairs. To enable searching, click the check box. In the first row of the property



name and property value table, click inside the edit box, delete the existing text, and type the property name and value. To add a row,

use the **Add row** button ()

For information about subsystem property names and values, in “Block-Specific Parameters”, see the “Ports & Subsystems Library Block Parameters” section.

## Section Options

- **Create section for each object in loop:** Inserts a section in the generated report for each object found in the loop.
- **Display the object type in the section title:** Inserts the object type automatically into the section title in the generated report.
- **Create link anchor for each object in loop:** Creates a hyperlink to the object in the generated report.

## Insert Anything into Report?

Yes, inserts a section if you select the **Create section for each object in loop** option.

## Class

rptgen\_fp.cfp\_blk\_loop

## See Also

Block Loop, Model Loop, Signal Loop, Simulink Linking Anchor, System Loop

# Fixed Point Logging Options

---

## Purpose

Set fixed-point options like in Fixed Point Tool

## Description

This component sets fixed-point options like those set in the Fixed Point Tool (invoked by running the `fxptdlg` function).

This component must be a child of the `Model Loop` component. Use this component to set the following options on the current model:

- Data type override
- Fixed-point instrument mode
- Logging type

This component can have child components. It is a good practice to use this component with a `Model Simulation` component as its child. This approach sets fixed-point properties for the model for the purpose of the simulation, and then restores them to their original values after the simulation is complete.

## Data Type Override

- **Use local settings:** Overrides data types according to the value of this parameter set for each subsystem. Otherwise, settings for parent systems override those of child systems.
- **Scaled double:** Overrides the output data type of all blocks in the current system or subsystem with doubles. However, this option maintains the scaling and bias specified in the mask of each block.
- **Doubles:** Overrides the output data type of all blocks in the current system or subsystem with doubles. The overridden values have no scaling or bias.
- **Singles:** Overrides the output data type of all blocks in the current system or subsystem with singles. The overridden values have no scaling or bias.
- **Off:** Does not perform any data type override on any block in the current system or subsystem.

**Fixed-Point Instrumentation Mode** Specify logging options in this section. For logged blocks, minimum and maximum simulation values are written to the workspace.

- **Use local settings:** Logs data according to the value of this parameter set for each subsystem. Otherwise, settings for parent systems always override those of child systems.
- **Min, max, and overflow:** Logs minimum value, maximum value, and overflow data for all blocks in the current system or subsystem.
- **Overflow only:** Logs only overflow data for all blocks in the current system or subsystem.
- **Force off:** Logs no data for any block in the current system or subsystem. Use this selection to work with models containing fixed point-enabled blocks, if you do not have a Simulink Fixed Point license.

For more information on logging simulation results, see “Propose Fraction Lengths Using Simulation Range Data” in the Simulink Fixed Point documentation.

## Logging Type

Specify how to record logs in this section:

- **Overwrite log:** Clears information in the logs before new logging data is entered.
- **Merge log:** Merges new logging data with previously logged information.

## Insert Anything into Report?

No.

## Class

rptgen\_fp.cfp\_options

## See Also

Model Simulation

# Fixed Point Property Table

---

<b>Purpose</b>	Insert table that reports on Simulink Fixed Point block property name/property value pairs
<b>Description</b>	This component inserts a table that reports on Simulink Fixed Point block property name/property value pairs.
<b>Table</b>	<p>Select a preset table, which is already formatted and configured, in the <b>preset table</b> list in the upper-left corner of the attributes page.</p> <ul style="list-style-type: none"><li>• <b>preset table</b> Specifies the type of object property table.<ul style="list-style-type: none"><li>▪ Default</li><li>▪ Mask properties</li><li>▪ Block limits</li><li>▪ Out-of-range errors</li><li>▪ All fixed-point properties</li><li>▪ Blank 4x4</li></ul>To apply the specified table, select the table and click <b>Apply</b>.</li><li>• <b>Split property/value cells:</b> Split property name/property value pairs into separate cells. For the property name and property value to appear in adjacent horizontal cells in the table, select the <b>Split property/value cells</b> check box. In this case, the table is in split mode, so there only one property name/property value pair can exist in a cell. If there is more than one name/property pair in a cell, only the first pair appears in the report. The report ignores all subsequent pairs.  For the property name and property value to appear together in one cell, clear the <b>Split property/value cells</b> check box. That option specifies nonsplit mode. Nonsplit mode supports more than one property name/property value pair and text.  Before switching from nonsplit mode to split mode, make sure that there is only one property name/property value pair per table cell. If</li></ul>

you have more than one property name/property value pair or text in one cell, only the first value pair appears in the report. Subsequent pairs and text are omitted.

- **Display outer border:** Display the outer border of the table in the generated report.

## Table Cells

Select table properties to modify. The selection in this pane affects the available fields in the **Cell Properties** pane.

## Cell Properties

- **Contents**  
Modify the contents of the table cell selected in the **Table Cells** pane.
- **Show as:** Specifies the format for the contents of the table cell.
  - PROPERTY Value
  - Value
  - Property Value
  - Property: Value
  - PROPERTY: Value
  - Property - Value
  - PROPERTY - Value
- **Alignment:** Aligns the contents of the table cell.
  - Center
  - Left
  - Right
  - Double justified
- **Lower border:** Displays the lower border of the table in the generated report.
- **Right border:** Displays the right border of the table in the generated report.

# Fixed Point Property Table

---

## Creating Custom Tables

To create a custom table, edit a preset table, such as the Blank 4x4 table. Add and delete rows and add properties. To open the Edit Table dialog box, click **Edit**.

For details about creating custom property tables, see “Property Table Components” on page 6-6.

## Insert Anything into Report?

Yes. Table.

## Class

rptgen\_fp.cfp\_prop\_table

## See Also

Fixed Point Summary Table

# Fixed Point Summary Table

---

**Purpose** Table of specified fixed-point block properties or parameters

**Description** This component displays properties or parameters of specified fixed-point blocks in a table.

**Properties** **Table title**  
Choose a table title in the generated report:

- **Automatic:** Generates a title automatically from the parameter.
- **Custom:** Specifies a custom title.

**Property Columns** **Property name**  
This field displays the object properties to include in the Summary Table in the generated report.

- To add a property:
  - 1 Select the appropriate property level in the menu
  - 2 Select the property to add from the selection list and click **Add**.
- To delete a property, select the property name and click the **Delete** button.
- To move properties up and down in the list, click the **Up** and **Down** buttons.

---

**Note** Some entries in the list of available properties (such as Depth) are “virtual” properties that you cannot access using the `get_param` command. The properties used for property/value filtering in the block and system loop components must be retrievable by the `get_param`. Therefore, you cannot configure your Summary Table to report on all blocks of `Depth == 2`.

---

**Transpose table**

# Fixed Point Summary Table

---

Enabling this check box changes the summary table rows into columns in the generated report, putting the property names in the first column and the values in the other columns.

## Object Rows

- **Insert anchor for each row:** Inserts an anchor for each row in the summary table.
- **Report On:** Specifies blocks on which to report:
  - **Automatic list from context.** Reports on all blocks in the current context.
  - **Custom - use block list.** Reports on a specified list of blocks. To include a given block in the report, specify its full path.

## Loop Options

- **Sort blocks:** Specifies how to sort blocks (applied to each level in a model):
  - **Alphabetically by block name.** Sorts blocks alphabetically by name.
  - **Alphabetically by system name.** Sorts systems alphabetically. Lists blocks in each system, but in no particular order.
  - **Alphabetically by full Simulink path.** Sorts blocks alphabetically by Simulink path.
  - **By block type.** Sorts blocks alphabetically by block type.
  - **By block depth.** Sorts blocks by their depth in the model.
  - **By layout (left to right):** Sorts blocks by their location in the model layout, by *rows*. The block appearing the furthest toward the left top corner of the model is the anchor for the row. The row contains all other blocks that overlap the horizontal area defined by the top and bottom edges of the anchor block. The other rows use the same algorithm, using as the anchor the next unreported block nearest the left top of the model.



# Fixed Point Summary Table

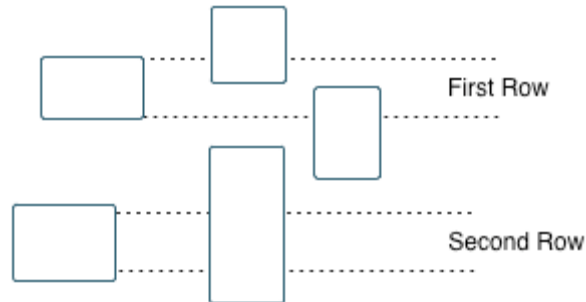

- By layout (top to bottom): Sorts blocks by their location in the model layout, by *columns*. The block appearing the furthest toward the left top corner of the model is the anchor for the column. The column contains all other blocks that overlap the vertical area defined by the left and right edges of the anchor block. The other columns use the same algorithm, using as the anchor the next unreported block nearest the left top of the model.
- By traversal order. Sorts blocks by traversal order.
- By simulation order. Sorts blocks by execution order.
- **Search for Simulink property name/property value pairs:** Reports only on Simulink blocks with specified property name/property value pairs.

## Insert Anything into Report?

Yes. Table.

## Class

rptgen\_fp.cfp\_summ\_table

## See Also

Fixed Point Property Table

# Import Generated Code

---

<b>Purpose</b>	Import source and header files generated by Simulink Coder software, and custom files specified as part of model
<b>Description</b>	This component imports source and header files generated by Simulink Coder software. It also imports custom files that you specify as part of your model.
<b>Properties</b>	<ul style="list-style-type: none"><li>• <b>Source files (auto-generated):</b> Includes the following files in the report:<ul style="list-style-type: none"><li>▪ .c and .cpp source files generated by Simulink Coder software.</li><li>▪ Simulink Coder source files, such as the setup file and supporting files in the build folder. This check box is selected by default. Clear it to omit source files.</li></ul></li><li>• <b>Header files (auto-generated):</b> Includes the following files in the report:<ul style="list-style-type: none"><li>▪ .h and .hpp header files generated by Simulink Coder software.</li><li>▪ Simulink Coder header files in the build folder. This check box is selected by default. Clear it to omit source files.</li></ul></li><li>• <b>Custom files:</b> Includes custom source files that you specify in the <b>Code Generation &gt; Custom Code</b> pane of the Configuration Parameters dialog box. This check box is deselected by default.</li></ul>
<b>Insert Anything into Report?</b>	Yes. Generated code listings.
<b>Class</b>	RptgenRTW.CImportCode
<b>See Also</b>	Code Generation Summary

## Purpose

Report on lookup table blocks

## Description

The Look-Up Table component reports on the following lookup table blocks:

- 1-D Lookup Table
- 2-D Lookup Table
- n-D Lookup Table

It inserts a figure and/or table into the report. The table contains input and output numeric values; a figure plots these values.

## Look-Up Table Options

This pane allows you to specify the types of lookup table blocks to include in the report and how they appear. If you select none of the check boxes in this pane, the component does not insert anything into the report.

- The Look-Up Table displays results according to the type of its parent component:
  - **Model Loop:** Includes all lookup tables in the current model.
  - **System Loop.:** Includes all lookup tables in the current system.
  - **Block Loop.:** If the current block is a lookup table, the reports that block.
  - **Signal Loop:** Includes all lookup tables connected to the current signal.
  - If the Look-Up Table does not have any of the looping components as its parent, it includes all lookup tables in all open models.
- **Plot 1-D data:** Plots data from a 1-D Lookup Table block. Choose the plot type, **Line plot** or **Bar plot**, from the corresponding list. The input data appears on the horizontal or *x*-axis, and the output data appears on the vertical or *y*-axis.

# Look-Up Table

---

For more information on line and bar plots, see “2-D and 3-D Plots” in the MATLAB Graphics documentation.

- **Create table for 1-D data:** Creates a table that contains numeric data values from the 1-D Lookup Table block.
- **Plot 2-D data:** Creates a plot of 2-D Lookup Table blocks. You can specify whether the data appears as a surface plot or a line plot. The line plot is best for small data sets, and the surface plot for larger tables. For more information on surface and line plots, see “2-D and 3-D Plots” in the MATLAB Graphics documentation.

---

**Note** This option creates a 2-D slice through n-D data.

---

- **Create table for 2-D data:** Creates a table that contains numeric data values from the 2-D Lookup Table block.
- **Create table for N-D data:** Creates a table that contains numeric data values from the n-D Lookup Table block.
- **Image file format:** Specifies the image file format. Select `Automatic HG Format` (the default) to choose automatically the format best suited for the output format that you chose in the Report component. Otherwise, choose an image format that your output viewer can read.
  - `Automatic SL Format` (Uses the Simulink file format selected in the Preferences dialog box)
  - `Bitmap (16m-color)`
  - `Bitmap (256-color)`
  - `Black and white encapsulated PostScript`
  - `Black and white encapsulated PostScript (TIFF)`
  - `Black and white encapsulated PostScript2`
  - `Black and white encapsulated PostScript2 (TIFF)`

## Print Options

- Black and white PostScript
  - Black and white PostScript2
  - Color encapsulated PostScript
  - Color encapsulated PostScript (TIFF)
  - Color encapsulated PostScript2
  - Color encapsulated PostScript2 (TIFF)
  - Color PostScript
  - Color PostScript2
  - JPEG high quality image
  - JPEG medium quality image
  - JPEG low quality image
  - PNG 24-bit image
  - TIFF - compressed
  - TIFF - uncompressed
  - Windows metafile
  - **Paper orientation:**
    - Landscape
    - Portrait
    - Rotated
    - Use figure orientation: Uses the orientation for the figure, which you set with the `orient` command.
    - Full page image (PDF only): In PDF reports, scales images to fit the full page, minimizes page margins, and maximizes the size of the image by using either a portrait or landscape orientation.
- For more information about paper orientation, see the `orient` command in the MATLAB documentation.

# Look-Up Table

---

- **Image size:** Allows you to specify the image size in the report by selecting Use figure PaperPositionMode setting and setting the PaperPositionMode property of the Handle Graphics figure.
  - Automatic (same size as on screen):
  - Custom: Specifies a custom image size. Set the image size using the **Size** field and **Units** list.

For more information on paper position mode, see `orient` in the MATLAB documentation.
- **Size:** Allows you to enter the size of the Handle Graphics figure snapshot in the format `wxh`(width times height). This field is active only if you choose **Custom** in the **Image size** list box.
- **Units:** Allows you to enter for the size of the Handle Graphics figure snapshot. This field is active only if you choose **Custom** in the **Image size** list box.
- **Invert hardcopy:** Causes the Handle Graphics `InvertHardcopy` property to invert colors for printing. In other words, this option changes dark colors to light colors and light colors to dark colors. To change colors in your image, choose one of the following options:
  - Automatic: Automatically changes a dark axes colors to light axes colors. If the axes color is a light color, this option does not invert the color.
  - Invert: Changes dark axes colors to light axes colors, and light axes colors to dark axes colors.
  - Don't invert: Does not change the colors in the image that appears on the screen for printing.
  - Use figure's `InvertHardcopy` setting: Uses the `InvertHardcopy` property set in the Handle Graphics image.
  - Make figure background transparent: Makes the image background transparent.

## Display Options

- **Scaling:**
  - **Fixed size:** Specifies the number and type of units.
  - **Zoom:** Specifies the percentage, maximum size, and units of measure.
  - **Use image size:** Sets the size of the image in the report to the same size as it is on screen.
- **Size:** Specifies the size of the snapshot in the form *w h* (width, height) format. This field is active only if you choose **Fixed size** in the **Scaling** selection list.
- **Max size:** Specifies the maximum size of the snapshot in the form *w h* (width, height). This field is active only if you choose **Zoom** from the **Scaling** selection list.
- **Units:** Allows you to enter units for the size of the snapshot. This field is active only if you choose **Zoom** or **Fixed size** in the **Image size** list box.
- **Alignment:** Only reports in PDF or RTF format support this property.
  - Auto
  - Right
  - Left
  - Center
- **Title:** Enter text to appear above the snapshot.
- **Caption:** Enter text to appear under the snapshot.

## Insert Anything into Report?

Yes. Figure and/or table.

## Class

rptgen\_sl.csl\_blk\_lookup

# Look-Up Table

---

## **See Also**

Block Loop, Model Loop, Signal Loop, System Loop



<b>Purpose</b>	Run child components for specified Stateflow machines
<b>Description</b>	This component runs its child components for selected Stateflow machines. The behavior of this component depends on its parent component. If it has no parent, the <b>Machine Loop</b> runs its child components for all machines. If it has the <b>Model Loop</b> as its parent, it runs its child components for all machines in the model.
<b>Loop Options</b>	<b>Search Stateflow</b> If selected, searches states that you specify in the field that appears under the check box.
<b>Section Options</b>	<ul style="list-style-type: none"><li>• <b>Create section for each object in loop:</b> Inserts a section in the generated report for each object in the loop.</li><li>• <b>Display the object type in the section title:</b> Inserts the object type automatically into the section title in the generated report.</li><li>• <b>Create link anchor for each object in loop:</b> Creates a hyperlink to each object in the loop.</li></ul>
<b>Insert Anything into Report?</b>	Yes, inserts a section if you select the <b>Create section for each object in loop</b> option.
<b>Class</b>	rptgen_sf.csf_machine_loop
<b>See Also</b>	Model Loop

# Missing Requirements Block Loop

---

**Purpose** Apply all child components to blocks that do not have requirements

**Description** This component runs its child components for each block in the current system, model, or signal that do not have associated requirements.

For more information on working with looping components, see “Dynamic Reporting Components” on page 6-22.

**Report On** This pane describes the type of object on which this component operates.

- **Automatic list from context:** Report on all blocks in the current context that do not have associated requirements. The parent component of the Block Loop component determines its context. If this component does not have the Model Loop, System Loop, Signal Loop, or Block Loop as its parent, selecting this option causes this component to report on all blocks in all models that do not have associated requirements.
  - **Model Loop:** Reports on all blocks in the current model with no associated requirements.
  - **System Loop:** Reports on all blocks in the current system with no associated requirements.
  - **Signal Loop:** Reports on all blocks connected to the current signal with no associated requirements.
- **Custom - use block list:** Enables you to specify a list of blocks on which to report. Enter the full path of each block.

**Loop Options** Choose block sorting options and reporting options in this pane.

- **Sort blocks:**

Use this option to select how to sort blocks (applied to each level in a model):

  - **Alphabetically by block name:** Sorts blocks alphabetically by their names.

# Missing Requirements Block Loop

- Alphabetically by system name: Sorts systems alphabetically. Lists the blocks in each system, but in no particular order.
- Alphabetically by full Simulink path: Sorts blocks alphabetically by Simulink path.
- By block type: Sorts blocks alphabetically by block type.
- By block depth: Sorts blocks by their depth in the model.
- By layout (left to right): Sorts blocks by their location in the model layout, by *rows*. The block appearing the furthest toward the left top corner of the model is the anchor for the row. The row contains all other blocks that overlap the horizontal area defined by the top and bottom edges of the anchor block. The other rows use the same algorithm, using as the anchor the next unreported block nearest the left top of the model.

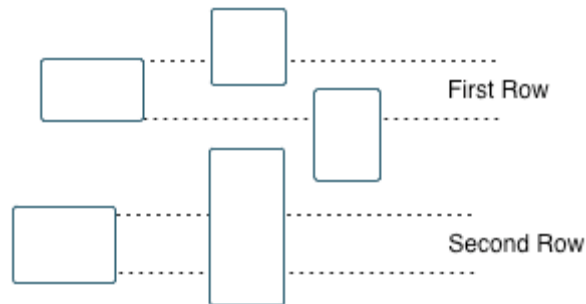

- By layout (top to bottom): Sorts blocks by their location in the model layout, by *columns*. The block appearing the furthest toward the left top corner of the model is the anchor for the column. The column contains all other blocks that overlap the vertical area defined by the left and right edges of the anchor block. The other columns use the same algorithm, using as the anchor the next unreported block nearest the left top of the model.
- By traversal order. Sorts blocks by traversal order.
- By simulation order. Sorts blocks by execution order.

# Missing Requirements Block Loop

---

- `%<VariableName>`: Inserts the value of a variable from the MATLAB workspace. The `%<>` notation can denote a string or cell array. The following example reports on the `theta dot` integrator block and the `theta` integrator block in the model `simppend`, using the variable `Z={ 'simppend/theta' }`:

```
simppend/theta dot
%<Z>
```

The generated report includes information about the following blocks:

- `simppend/theta dot`
- `simppend/theta`

For more information, see `%<VariableName>` Notation on the Text component reference page in the MATLAB Report Generator documentation.

- **Search for Simulink property name/property value pairs**: Reports only on Simulink blocks with specified property name/property value pairs that do not have associated requirements.

## Section Options

- **Create section for each object in loop**: Inserts a section in the generated report for each block found in the loop.
- **Display the object type in the section title**: Automatically inserts the object type into the section title in the generated report.
- **Create link anchor for each object in loop**: Create a hyperlink to the block in the generated report.

## Insert Anything into Report?

Yes, inserts a section if you select the **Create section for each object in loop** option.

# Missing Requirements Block Loop

---

**Class  
Name**

RptgenRMI.NoReqBlockLoop

**See Also**

Block Loop, Missing Requirements System Loop, Requirements Block Loop, Requirements Documents Table, Requirements Signal Loop, Requirements Summary Table, Requirements System Loop, Requirements Table

# MATLAB Function

---

## Purpose

Insert information about MATLAB Function block contents

## Description

This component displays tables with information about MATLAB code included in MATLAB Function blocks. You specify which of the following kinds of information to include in the report:

- Function properties — Parameter settings for the MATLAB Function block
- Argument properties — Properties of the function arguments (for example, complexity)
- The function script — MATLAB code of the function
- Supporting functions — User-defined functions and, optionally, MATLAB functions that are included in the MATLAB Function block function.

For details about MATLAB Function blocks, see the MATLAB Function block reference page.

Use the MATLAB Function component within a section, paragraph, or table.

---

**Note** To view the contents of a MATLAB Function block in a Web viewer, use the Web view feature of the Simulink Report Generator. In the Web view, hover your cursor over the MATLAB Function block. For details, see “Web Display of Model Information”.

---

## Function Properties Table

- **Include function properties:** Generates a table with function property information.
- **Table title:** Insert a title for the function properties table.
  - Automatic: Use the default title for the table.
  - Custom: Use the title that you specify for the table.

## Argument Summary Table

- You can change the header text for property and value columns of the function properties table. In the **Header** column, double-click to change the header text. The **Width** column indicates the relative width, in relative terms, based on the smallest width you specify. For example, for a three-column table, if the first column width is 1, and the column width of the other two columns is 3, then the second and third columns is three times wider than the first column.
- **Grid lines:** Show grid lines for the table.
- **Spans page width:** Make the table as wide as the page.
- **Include argument summary table:** Generate a table with summary information about the MATLAB Function block function arguments.
- **Table title:** Insert a title for the argument summary table.
  - **Automatic:** Use the default title for the table.
  - **Custom:** Use the title that you specify for the table.
- **Argument Summary Table Options:** Specify the property columns to include in the table.
  - **To add a property column:**
    - 1** In the table on the right, select a property near where you want to insert the new property column.
    - 2** From the list of properties to the left of the table, select a property that you want to add to the table.
    - 3** Click the left-arrow button.
    - 4** If necessary, use the up or down arrow button to position the new column.
  - **To delete a property column,** select the property in the table and click the right-arrow button
  - You can change the header text for property and value columns of the table. In the **Header** column, double-click to change the header

text. The `Width` column indicates the relative width, in relative terms, based on the smallest width you specify. For example, for a three-column table, if the first column width is 1, and the column width of the other two columns is 3, then the second and third columns is three times wider than the first column.

- **Grid lines:** Show grid lines for the table.
- **Spans page width:** Make the table as wide as the page.
- **Column alignment:** Align the text in each column:
  - Left
  - Center
  - Right
  - Double justified
- **Include detailed argument report:** Generate a table with detailed information about the MATLAB Function block function arguments.
- **Argument Property Table Format Options:** Specify the argument property columns to include in the table.
  - **Table title:** Insert a title for the argument properties table.
    - Automatic: Use the default title for the table.
    - Custom: Use the title that you specify for the table.
  - You can change the header text for property and value columns of the table. In the `Header` column, double-click to change the header text.
  - **Grid lines:** Show grid lines for the table.
  - **Spans page width:** Make the variable table as wide as the page on which the table appears.
- **Include function script:** Include the script for the function.
- **Highlight script syntax:** Use colors to highlight syntax keywords.

## Detailed Argument Report



- **Include supporting functions:** Include a list of functions invoked directly or indirectly by the function script. If you specify to include supporting functions in the report, also specify whether to include both MATLAB and user-defined functions or just user-defined functions.
- **Supporting Function Table Format Options:**
  - **Table title:** Insert a title for the supporting functions table.
    - Automatic: Use the default title for the table.
    - Custom: Use the title that you specify for the table.
  - You can change the header text for property and value columns of the table. In the **Header** column, double-click to change the header text. The **Width** column indicates the relative width, in relative terms, based on the smallest width you specify. For example, for a three-column table, if the first column width is 1, and the column width of the other two columns is 3, then the second and third columns is three times wider than the first column.
  - **Grid lines:** Show grid lines for the table.
  - **Spans page width:** Make the table as wide as the page.

## Insert Anything into Report?

Yes. Tables and, optionally, code.

## Class

rptgen\_sl.csl\_emlfcn

## See Also

Stateflow Property

# Missing Requirements System Loop

---

- Purpose** Loop only on systems and subsystems that do not have associated requirements
- Description** This component runs its child components for each system or subsystem defined by the parent component that does not have associated requirements. Insert this component as the child of a `Model Loop` component to include systems and subsystems that do not have any associated requirements in the report.
- Report On**
- **Loop on Systems:**
    - **Select systems automatically:** Reports on all systems in the current context that do not have associated requirements.
      - `Model Loop`: Reports on systems in the current model.
      - `System Loop`: Reports on the current system.
      - `Signal Loop`: Reports on the parent system of the current signal.
      - `Block Loop`: Reports on the parent system of the current block. If this component does not have any of these components as its parent, selecting this option reports on all systems in all models that do not have associated requirements.
  - **Custom - use system list:** Reports on a list of specified systems. Specify the full path of each system.
  - `%<VariableName>`: Inserts the value of a variable from the MATLAB workspace. The `%<>` notation can denote a string or cell array. For more information, see `%<VariableName> Notation on the Text component reference page`.
- Loop Options**
- **Sort Systems:** Specifies how to sort systems.
    - **Alphabetically by system name (default):** Sorts systems alphabetically by name.
    - **By number of blocks in system:** Sorts systems by number of blocks. The list shows systems by decreasing number of blocks. In

# Missing Requirements System Loop

---

other words, it shows the system with the largest number of blocks that do not have requirements appears first in the list.

- **By system depth:** Sorts systems by their depth in the model.
- **By traversal order:** Sorts systems in the traversal order.
- **Search for:** Reports only on blocks with the specified property name/property value pairs. To enable searching, click the check box. In the first row of the property name and property value table, click inside the edit box, delete the existing text, and type the property

name and value. To add a row, use the **Add row** button (.

For information about subsystem property names and values, in “Block-Specific Parameters”, see the “Ports & Subsystems Library Block Parameters” section.

## Section Options

- **Create section for each object in loop:** Inserts a section in the generated report for each object found in the loop.
- **Display the object type in the section title:** Inserts the object type automatically into the section title in the generated report.
- **Number sections by system hierarchy:** Hierarchically numbers sections in the generated report. Requires that **Sort Systems** be set to **By traversal order**.
- **Create link anchor for each object in loop:** Creates a hyperlink to the object in the generated report.

## Insert Anything into Report?

Yes, inserts a section if you select the **Create section for each object in loop** option.

## Class

RptgenRMI.NoReqSystemLoop

# Missing Requirements System Loop

---

## **See Also**

Block Loop, Missing Requirements Block Loop, Requirements Block Loop, Requirements Documents Table, Requirements Signal Loop, Requirements Summary Table, Requirements System Loop, Requirements Table, System Loop

<b>Purpose</b>	Insert Model Advisor report or link to Model Advisor report for current model
<b>Description</b>	This component inserts a Model Advisor report for the current model into the report if the report is in HTML format. For other report formats, it inserts a link to a Model Advisor report for the current model. For more information about Model Advisor reports, see “About the Model Advisor” in the Simulink documentation.
<b>Properties</b>	<b>Use existing report:</b> Includes an existing Model Advisor report in the report. This check box is selected by default. Clearing this option generates a new Model Advisor report.
<b>Insert Anything into Report?</b>	Yes, a Model Advisor report.
<b>Class</b>	rptgen_sl.CModelAdvisor
<b>See Also</b>	Model Change Log

# Model Change Log

---

**Purpose** Construct model history table that displays model revision information

**Description** Run this component before you run the Model Simulation component. It uses a reported model's ModifiedHistory parameter to construct a model history table that displays information about each logged revision to the model. This model history table includes:

- The author of each change
- The model version of the change
- The time and date of the change
- A description of the change

For more information on model history, see “Log Comments History” in the Simulink documentation.

---

**Tip** If your model has a long revision history, consider limiting the number of revisions reported.

---

**Table Columns** Choose the information displayed in the model revision table in this section:

- **Author name:** Includes the name of the person who last revised the model.
- **Version:** Includes the version number of the model.
- **Date changed:** Includes the revision date of the model.
- **Description of change:** Includes a description of the revision to the model.

## Table Rows

- **Limit displayed revisions to:** Limits the number of revisions that appears in the report.
- **Show revisions since date:** Limits the number of revisions that appears in the report by date. Enter the date in the corresponding text field. This field supports %<varname> notation. For example, the default value, %<datestr(now-14)>, returns revision history for the last two weeks.

## Table Display

Choose how the model revision history table appears in this section.

- **Table title:** Specifies the title of the table.
- **Sort order:** Sorts the table entries from most recent to oldest, or from oldest to most recent.
- **Date format:** Specifies a preferred date format for the date/time stamps in the table.

## Insert Anything into Report?

Yes. Table.

## Class

rptgen\_sl.csl\_md1\_changelog

## See Also

Model Advisor Report

# Model Configuration Set

---

<b>Purpose</b>	Insert active configuration set of a model into a report
<b>Description</b>	<p>This component displays a table with the active configuration set for the model.</p> <p>For information about configurations sets, see “Manage a Configuration Set”.</p>
<b>Display Options</b>	<ul style="list-style-type: none"><li>• <b>Title:</b> Specifies a title for the table in the generated report.<ul style="list-style-type: none"><li>▪ <b>Automatic:</b> Generates a title automatically from the parameter.</li><li>▪ <b>Custom:</b> Specifies a custom title.</li><li>▪ <b>None:</b> Uses no title.</li></ul></li><li>• <b>Show configuration set table grids:</b> Show grid lines for the table.</li><li>• <b>Make configuration set tables page wide:</b> Make the table as wide as the page.</li></ul>
<b>Insert Anything into Report?</b>	Yes. Table.
<b>Class</b>	rptgen_sl.csl_md1_cfgset
<b>See Also</b>	Model Loop, System Loop







**Purpose** Loop on Simulink models and systems, as specified by child components

**Description** This component loops on Simulink models and systems, as specified by child components. For example, you can use a **Model Loop** with a child **System Loop** to report on the subsystems of the specified system.

Consider making these components children of the **Model Loop** (although the **Model Loop** not necessarily required to be the immediate parent of a given component).

**Models to Include** You can add a model to the list by clicking **Add New Model to List**. The following table shows the buttons you can use to move a model up or down in the list, or to add or delete a model.

Button	Action
	Move a model up in the list.
	Move a model down in the list.
	Remove a model from the list.
	Add a new model to the list.

## Model Options

- **Active:** Includes a given model in the loop. This option is selected by default. Clearing this option omits the model from the loop.

This option allows you to temporarily omit one or more models from a report.

- **Model name:** Specifies the model name.
  - Current block diagram
  - All open models
  - All open libraries

- Block diagrams in current directory
- Custom block diagram: Selecting this option automatically sets the **Starting system(s)** field \$top to start in the model root system.
- %<VariableName>: For more information, see %<VariableName> Notation on the Text component reference page in the MATLAB Report Generator documentation.
- **Traverse model:** Specifies the systems to traverse.
  - All systems in model
  - Selected system(s) only
  - Selected system(s) and ancestors
  - Selected system(s) and children
- **Look under masks:** Specifies how to handle masks.
  - Functional masks only
  - No masks
  - All masks
  - Graphical masks onlyFor more information, see “Masking” in the Simulink documentation.
- **Follow library links:** Specifies library links to include.
  - Do not follow library links
  - Include library links
  - Include unique library linksFor more information, see “Create a Linked Block” in the Simulink documentation.
- **Model reference:** Specifies whether to report on models referenced by a Model block. If you want to report on referenced models, then you can control the depth of the model referencing hierarchy and whether to report on model reference variants.

- Do not follow model reference blocks: Do not report on blocks contained in referenced models.
- Follow all model reference blocks: Report on blocks contained in all models that any part of the model hierarchy references.
- Follow model reference blocks defined in current model: Report on blocks in models that the currently selected model references.
- <Custom model reference depth>: Report on blocks in models that your specified level in the model reference hierarchy references.
- **Include all variants:** Report on all model reference variants. To enable this option, set the **Model reference** option to report on blocks in referenced models.
- **Starting system(s):** Specifies the system in which to start the loop. Available options depend on the value that you select in the **Traverse model** option. Selecting any option other than **All systems in model** for **Traverse model** activates the **Starting system(s)** option.

If you do not enter a model name in the **Model name** option, then select either **Root model** or **Current** to specify where to start the loop.

If you specify a model name in the **Model name** option, then the **Starting system(s)** option provides an edit box in which you can enter:

- The full path of a subsystem or subsystems
  - \$top to start the loop in the model root system
  - \$current to start the loop in the currently selected system
- **Create section for each object in loop:** Inserts a section in the generated report for each object found in the loop.
  - **Display the object type in the section title:** Inserts the object type automatically into the section title in the generated report.

## Section Options

- **Create link anchor for each object in loop:** Creates a hyperlink to the object in the generated report.

## Examples

### Generating Reports on Specified Systems and their Subsystems

This example shows how to loop over a specified system and its subsystems in the sample model `sldemo_auto_climate_elec`, which the Simulink software includes.

- 1** (Optional) To open the `sldemo_auto_climate_elec` model, at the MATLAB command prompt, enter the following command:

```
sldemo_auto_climate_elec
```

Explore the model to familiarize yourself with its subsystems.

- 2** Open the Report Explorer.
- 3** Create a report setup file by clicking **File > New**.
- 4** Save the report setup file by clicking **File > Save As**. Give it the name `sldemo_auto_report`.
- 5** Add a Chapter/Subsection component to the report setup file to include information about model subsystems:
  - a** In the Library pane in the middle, double-click Chapter/Subsection to add it to the report setup file.
  - b** For **Title**, choose Custom. In the title field, enter Description of subsystems.
- 6** Add a Model Loop as a child of the Chapter/Subsection component. This loops over the `ClimateControlSystem` system and its subsystems in the `sldemo_auto_climate_elec` model:
  - a** In the Library pane in the middle, double-click Model Loop to add it to the report setup file. By default, the Report Explorer adds that component as a child of the Chapter/Subsection component.

- b** In the Model Loop properties pane, from the **Model name** selection list, select <Custom block diagram> .
- c** In the **Model name** field, delete the text <Custom block diagram>, and then enter `sldemo_auto_climate_elec.slx`. Click any component in the report setup file to add this model to the **Models to include** list.
- d** In the **Traverse model** selection list, select Selected system(s) and children.
- e** In the **Look under masks** selection list, select All masks.
- f** In the **Model reference** selection list, select Do not follow model reference blocks.
- g** In the **Starting system(s)** field, enter `sldemo_auto_climate_elec/ClimateControlSystem`. Because you selected Selected system(s) and children for **Traverse model**, the Model Loop loops over `sldemo_auto_climate_elec/ClimateControlSystem` and its subsystems.
- h** Under **Section Options**, select the **Create section for each object in loop** check box. Selecting this option creates separate sections in the generated report for each model over which the component loops.

The Model Loop properties pane looks as follows.

# Model Loop

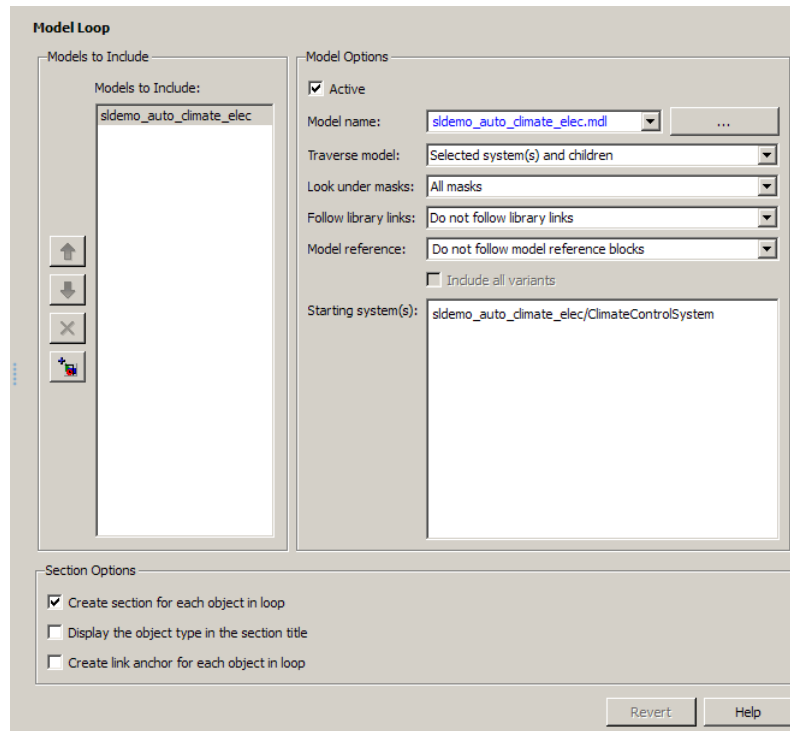

7 Save the report by clicking **File > Save**.

- 8 Add a System Loop as a child of the Model Loop component.
  - a In the Library pane in the middle, double-click System Loop to add it to the report setup file. By default, Model Explorer adds this component as a child of the Model Loop component.
  - b In the System Loop properties pane, under **Section Options**, select the **Create section for each object in loop** check box. Selecting this option creates a section in the generated report for each subsystem on which the component loops. Accept the default values for all other fields.
- 9 Add a System Snapshot component as a child of the System Loop component. This step creates snapshots of all the subsystems of ClimateControlSystem in the generated report. In the Library pane in the middle, double-click System Snapshot. By default, Model Explorer adds this component as a child of the System Loop component.
- 10 Save the report.

The report setup file hierarchy now looks as follows.

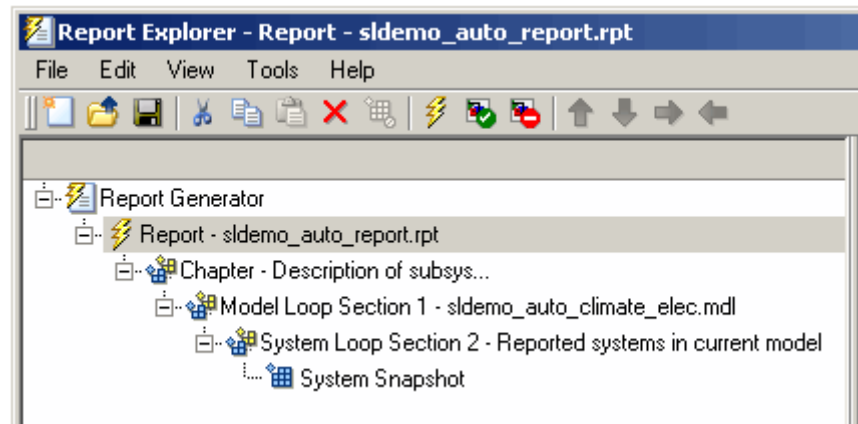

- 11 Run the report by clicking **File > Report**.

# Model Loop

---

The report loops on the system ClimateControlSystem of the sldemo\_auto\_climate\_elec model and all of its subsystems, as shown in the following Message List.

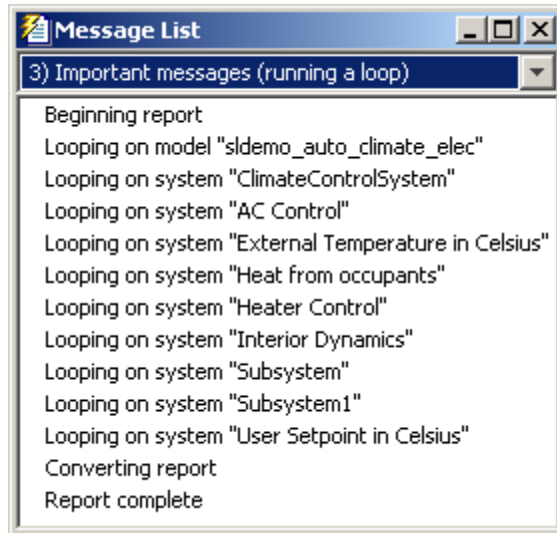

Below is an excerpt from the generated report.



## Chapter 1. Description of subsystems

### Table of Contents

- [sldemo\\_auto\\_climate\\_elec](#)
- [AC Control](#)
- [ClimateControlSystem](#)
- [External Temperature in Celsius](#)
- [Heat from occupants](#)
- [Heater Control](#)
- [Interior Dynamics](#)
- [Subsystem](#)
- [Subsystem1](#)
- [User Setpoint in Celsius](#)

### sldemo\_auto\_climate\_elec

#### AC Control

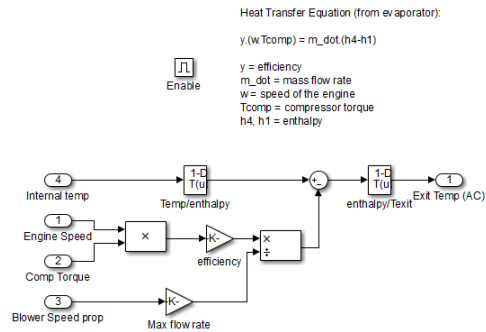

#### ClimateControlSystem

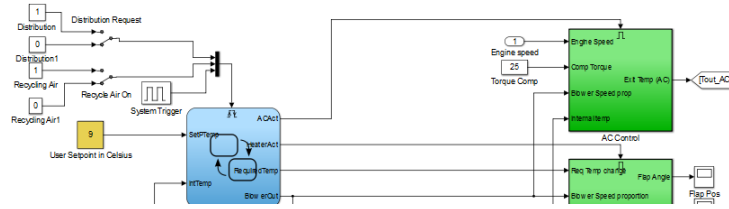

### Temporarily Omitting a Model from a Loop

This example shows how to use the Model Loop **Active** check box to temporarily omit a model from the loop. This example uses the report setup file that you created in Generating Reports on Specified Systems

# Model Loop

---

and their Subsystems, `sldemo_auto_report.rpt`, and the model `f14`, which the Simulink software includes.

- 1** In the Report Explorer, click **File > Open**, and then open `sldemo_auto_report.rpt` by double-clicking it.
- 2** In the Outline pane on the left, click **Model Loop Section 1 - sldemo\_auto\_climate\_elec**.
- 3** In the Model Loop properties pane, click the  button to add a model to the **Models to include** list.
- 4** In the Model Loop properties pane, from the **Model name** selection list, select `<Custom block diagram>`.
- 5** In the **Model name** field, delete the text `<Custom block diagram>` and enter `f14.mdl`.

The Model Loop properties pane now looks as follows.

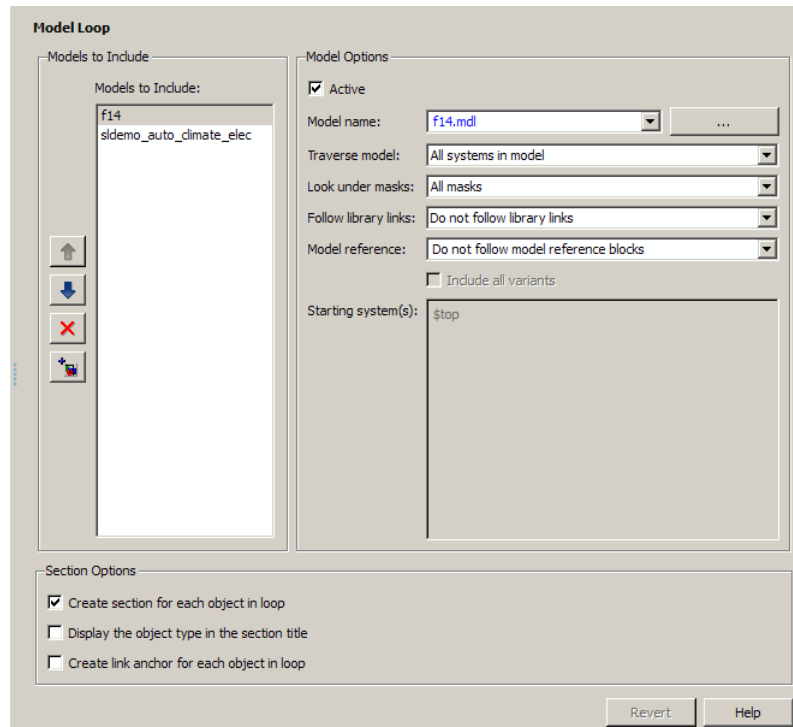

**6** Save the report setup file.

**7** Generate the report.

The report generation process loops over the specified systems in the f14 and sldemo\_auto\_climate\_elec models, as shown in the following message box.

# Model Loop

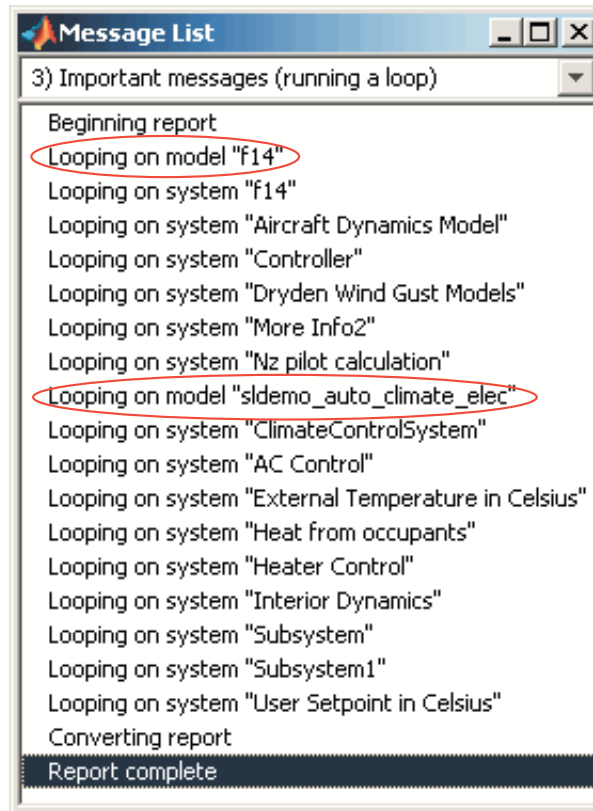

Below is an excerpt from the generated report.

## Chapter 1. Description of subsystems

### Table of Contents

- [f14](#)
- [Aircraft Dynamics Model](#)
- [Controller](#)
- [Dryden Wind Gust Models](#)
- [f14](#)
- [Nz pilot calculation](#)
- [sidemo auto climate elec](#)
- [AC Control](#)
- [ClimateControlSystem](#)
- [ElectricalSystem](#)
- [Heater Control](#)
- [Interior Dynamics](#)
- [sidemo auto climate elec](#)
- [Subsystem](#)
- [Subsystem](#)
- [Subsystem1](#)
- [Variable resistor \(with parasitic L\)](#)

### f14

#### Aircraft Dynamics Model

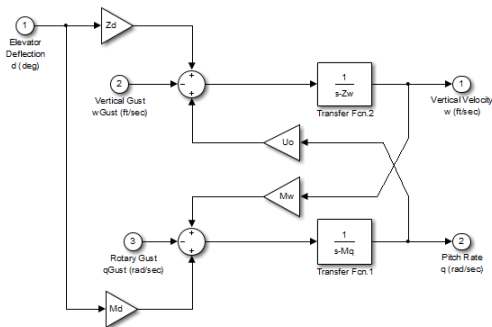

#### Controller

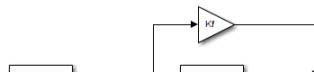

# Model Loop

---

- 8 In the **Models to include** list, click f14 to select it.
- 9 Clear the **Active** check box to omit f14 model information from the generated report.
- 10 Rerun the report.

The report now includes information only on the `sldemo_auto_climate_elec` model, as shown at the end of the previous example, *Generating Reports on Specified Systems and their Subsystems*.

- 11 To reactivate the f14 model, in the Model Loop **Models to include** list, select the f14 model and then select the **Active** check box.

## Insert Anything into Report?

Yes, inserts a section if you select the **Create section for each object in loop** option.

## Class

`rptgen_sl.cs1_md1_loop`

## See Also

Block Loop, System Loop

**Purpose**

Run current model with specified simulation parameters

**Description**

This component runs the current model using specified simulation parameters. Ensure that this component has the `Model Loop` component as its parent.

For more information on simulation parameters, see “Configure Simulation” in the Simulink documentation.

**I/O Parameters****Use model’s workspace I/O variable names**

Use the names of the parameters specified in the Simulation Parameters dialog box.

The following options are available if you do not select the **Use model’s workspace I/O variable names** option:

- **Time** : Specifies a new variable name for the `Time` parameter.
- **States**: Specifies a new variable name for the `States` parameter.
- **Output**: Specifies a new variable name for the `Output` parameter.

**Timespan**

**Use model’s timespan values**: Use the model’s `Start time` and `Stop time` values, as specified in the **Solver** tab in the Simulation Parameters dialog box.

The following options are available if you do not select the **Use model’s timespan values** option:

- **Start**: Specifies a simulation starting time.
- **Stop**: Specifies a simulation ending time.

# Model Simulation

---

---

**Note** If you set the stop time of your model to `inf` (infinity) in Simulink or on this component attribute page, Simulink Report Generator terminates the model simulation after 60 seconds. Terminating the report prevents the report generation process from entering an infinite loop.

---

## Simulation Options

- **Compile model before simulation:** Compiles the model before simulating, preserving scope content. Select this option if:
  - You use Simulink Coder Summary properties.
  - You sort systems or blocks by simulation order.
  - You use scope snapshots.
- **Simulation status messages:** Displays simulation status messages, or inserts them into the report.
  - Display to command line: Sends messages to a command-line window.
  - Display to Report Generator Message List: Sends messages to the Simulink Report Generator message window.
  - Insert into report: Includes messages in the report.
- **Simulation parameters:** Specifies simulation parameters.

## Insert Anything into Report?

No.

## Class

`rptgen_sl.csl_md1_sim`

## See Also

Model Loop



<b>Purpose</b>	Run child components for Stateflow objects, and then insert table into report
<b>Description</b>	This component runs its child components for each Stateflow object and inserts a table into the generated report.
<b>Object Types</b>	<ul style="list-style-type: none"><li>• <b>Report on “Data” objects:</b> Includes Stateflow data objects in the loop.</li><li>• <b>Report on “Event” objects:</b> Includes Stateflow event objects in the loop.</li><li>• <b>Report on “Transition” objects:</b> Includes Stateflow transition objects in the loop.</li><li>• <b>Report on “Junction” objects:</b> Includes Stateflow junction objects in the loop.</li><li>• <b>Report on “Target” objects:</b> Includes Stateflow target objects in the loop.</li><li>• <b>Report on “Note” objects:</b> Includes Stateflow note objects in the loop.</li></ul>
<b>Loop Options</b>	<ul style="list-style-type: none"><li>• <b>Report depth:</b> Specifies the level at which to loop:<ul style="list-style-type: none"><li>▪ Local children only (Default). Reports only on children one level down.</li><li>▪ All objects. Reports on all Stateflow objects.</li></ul></li><li>• <b>Skip autogenerated charts under truth tables:</b> Excludes autogenerated charts under truth tables from the report.</li><li>• <b>Remove objects which do not contain more information than a snapshot:</b> Excludes objects that contain only a snapshot.</li><li>• <b>Search Stateflow:</b> Reports on Stateflow charts with specified property name/property value pairs.</li></ul>

# Object Loop

---

## Section Options

- **Create section for each object in loop:** Inserts a section in the generated report for each object found in the loop.
- **Display the object type in the section title:** Automatically inserts the object type into the section title in the generated report.
- **Create link anchor for each object in loop:** Creates a hyperlink to the Stateflow object in the generated report.

## Insert Anything into Report?

Yes, inserts a section if you select the **Create section for each object in loop** option.

## Class

rptgen\_sf.csf\_obj\_loop

## See Also

Stateflow Filter, Stateflow Hierarchy, Stateflow Hierarchy Loop, Simulink Function System Loop

<b>Purpose</b>	Apply child components to blocks with requirements
<b>Description</b>	This component applies its child components to blocks with associated requirements.
<b>Report On</b>	<ul style="list-style-type: none"><li>• <b>Automatic list from context:</b> If selected, this option reports on all blocks in the current context. The parent of the Requirements Block Loop component determines its context.<ul style="list-style-type: none"><li>▪ <b>Model Loop:</b> Reports on all blocks with requirements in the current model.</li><li>▪ <b>System Loop:</b> Reports on all blocks with requirements in the current system.</li><li>▪ <b>Signal Loop:</b> Reports on all blocks with requirements connected to the current signal.</li></ul></li></ul> <p>If the Requirements Block Loop does not have the Model Loop, System Loop, Signal Loop, or Block Loop component as its parent, it reports on all blocks in all models.</p> <ul style="list-style-type: none"><li>• <b>Custom - use block list:</b> Reports on a list of blocks with specified requirements. Enter the full paths of each block into this field.</li></ul>
<b>Loop Options</b>	<ul style="list-style-type: none"><li>• <b>Sort blocks</b><p>Specify how to sort blocks (applied to each level in a model):</p><ul style="list-style-type: none"><li>▪ <b>Alphabetically by block name:</b> Sorts blocks alphabetically by name.</li><li>▪ <b>Alphabetically by system name:</b> Sorts systems and subsystems alphabetically by name. (Blocks in each system do not appear in alphabetical order).</li><li>▪ <b>Alphabetically by full Simulink path:</b> Sorts blocks alphabetically by Simulink path.</li><li>▪ <b>By block type:</b> Sorts blocks alphabetically by block type.</li><li>▪ <b>By block depth:</b> Sorts blocks by their depth in the model.</li></ul></li></ul>

# Requirements Block Loop

---

- **By layout (left to right):** Sorts blocks by their location in the model layout, by *rows*. The block appearing the furthest toward the left top corner of the model is the anchor for the row. The row contains all other blocks that overlap the horizontal area defined by the top and bottom edges of the anchor block. The other rows use the same algorithm, using as the anchor the next unreported block nearest the left top of the model.

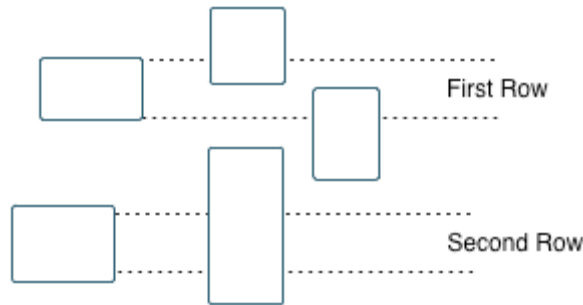

- **By layout (top to bottom):** Sorts blocks by their location in the model layout, by *columns*. The block appearing the furthest toward the left top corner of the model is the anchor for the column. The column contains all other blocks that overlap the vertical area defined by the left and right edges of the anchor block. The other columns use the same algorithm, using as the anchor the next unreported block nearest the left top of the model.
- **By traversal order:** Sorts blocks by traversal order.
- **By simulation order:** Sorts blocks by execution order.
- **Search for Simulink property name/property value pairs:** Reports on Simulink blocks with specified property name/property value pairs that have associated requirements.
- **Create section for each object in loop:** Inserts a section in the generated report for each block found in the loop that has associated requirements.

## Section Options

- **Display the object type in the section title:** Inserts the object type automatically into the section title in the generated report.
- **Create link anchor for each object in loop:** Creates a hyperlink to the block in the generated report.

## **Insert Anything into Report?**

Yes, inserts a section if you select the **Create section for each object in loop** option.

## **Class**

RptgenRMI.CBlockLoop

## **See Also**

Missing Requirements Block Loop, Missing Requirements System Loop, Model Loop, Requirements Block Loop, Requirements Documents Table, Requirements Signal Loop, Requirements Summary Table, Requirements System Loop, Requirements Table

# Requirements Documents Table

---

<b>Purpose</b>	Insert table of linked requirements documents
<b>Description</b>	This component creates a table that lists all requirements documents linked to model objects.
<b>Table Options</b>	<ul style="list-style-type: none"><li>• <b>Show documents linked to</b><ul style="list-style-type: none"><li>▪ <b>Simulink and Stateflow objects:</b> Inserts requirements documents linked to both Simulink and Stateflow objects in the model.</li><li>▪ <b>Simulink objects:</b> Inserts requirements documents linked only to Simulink objects in the model.</li><li>▪ <b>Stateflow objects:</b> Inserts requirements documents linked only to Stateflow objects in the model.</li></ul></li><li>• <b>Table title:</b> Specifies a title for the table.<ul style="list-style-type: none"><li>▪ <b>No title</b></li><li>▪ <b>Model name (Default)</b></li><li>▪ <b>Custom</b></li></ul></li></ul>
<b>Table Columns</b>	<ul style="list-style-type: none"><li>• <b>Replace document paths with links:</b> Inserts links to requirements documents when possible.</li><li>• <b>When replacing with links, note absolute vs. relative file path:</b> Indicates absolute or relative file paths when including links to requirements documents.</li><li>• <b>Include document modification time:</b> Includes the document modification information.</li><li>• <b>Count # references to each document:</b> Includes a count of the number of references to the requirements document in the model.</li></ul>
<b>Document References</b>	<ul style="list-style-type: none"><li>• <b>Replace file names with document IDs in the main body of the report:</b> Includes shortened IDs to identify requirements documents to simplify the requirements documents table.</li></ul>

# Requirements Documents Table

---

- **Retrieve full module path for DOORS links (requires login):**  
This option applies only to DOORS® requirements. Append the DOORS module ID to the module path in the DOORS database if the module information is not stored with the model.

## **Insert Anything into Report?**

Yes. Table.

## **Class**

RptgenRMI.ReqDocTable

## **See Also**

, Requirements Summary Table, Requirements Table

# Requirements Signal Loop

---

- Purpose** Apply all child components to signal groups with requirements
- Description** The Requirements Signal Loop component applies all child components to signal groups that have requirements in Signal Builder blocks.
- Properties**
- **Create link anchor for each object in loop:** Creates a hyperlink to each object with requirements in the loop.
  - **Display the object type in the section title:** Inserts the object name with requirements into the section title.
  - **Create section for each object in loop:** Creates a hyperlink to each object with requirements in the loop.
  - **Section Type:** Specifies the section type to insert. If you choose **Automatic**, the Simulink Report Generator software determines the appropriate section type:
    - Book
    - Chapter
    - Section 1
    - Section 2
    - Section 3
    - Section 4
    - Section 5
    - Simple Section
    - Automatic
- Report On** Loops on signal groups in systems:
- **Collect all Signal Builders:** Processes all Signal Builder blocks, looking for signal groups with requirements.



- **Custom - use list:** Processes all subsystems in the user-defined list. If a subsystem on the list does not have requirements, the Simulink Report Generator software does not include it in the report.

## **Insert Anything into Report?**

Yes, inserts a section if you select the **Create section for each object in loop** option.

## **Class**

RptgenRMI.CSystemLoop

## **See Also**

Missing Requirements Block Loop, Missing Requirements System Loop, Requirements Block Loop, Requirements Documents Table, Requirements Summary Table, Requirements System Loop, Requirements Table, Signal Loop

# Requirements Summary Table

---

<b>Purpose</b>	Properties of blocks, systems, or Stateflow objects with associated requirements
<b>Description</b>	This component displays properties of blocks, systems, or Stateflow objects with associated requirements.
<b>Object Type</b>	<p>Choose the object type to display in the generated report.</p> <ul style="list-style-type: none"><li>• Block (Default)</li><li>• System</li><li>• Stateflow</li></ul> <p>The selected object type affects the options available in the <b>Property Columns</b> pane.</p>
<b>Table Title</b>	<p>Specify a table title in the generated report.</p> <ul style="list-style-type: none"><li>• Automatic: Generates a title automatically from the parameter.</li><li>• Custom: Specifies a custom title.</li></ul>
<b>Property Columns</b>	<ul style="list-style-type: none"><li>• Object properties to include in the Requirements Summary Table appear in a list.<ul style="list-style-type: none"><li>▪ To add a property:<ol style="list-style-type: none"><li>1 Select the appropriate property level in the text box on the left.</li><li>2 In the text box on the right, select the property that you want to add and click <b>Add</b>.</li></ol></li><li>▪ To delete a property, select the property name and click <b>Delete</b>.</li></ul><p> %&lt;SplitDialogParameters&gt; is a unique property that you can specify for Requirements Summary Tables where the object type is Block. This property generates multiple summary tables, grouped</p></li></ul>

# Requirements Summary Table

---

by block type. Each Summary Table group contains the dialog box parameters for that block.

Some entries in the list of available properties (such as `Depth`) are “virtual” properties that you cannot access using the `get_param` command. The properties used for property/value filtering in the block and System Loop components must be retrievable by the `get_param`. Therefore, you cannot configure your Requirements Summary Table to report on all blocks of `Depth == 2`.

- **Remove empty columns:** Removes empty columns from the table.
- **Transpose table:** Changes the summary table rows into columns in the generated report, putting the property names in the first column and the values in the other columns.
- **Insert anchor for each row:** Inserts an anchor for each row in the Requirements Summary Table.
- **Report On**
  - **Automatic list from context:** Reports on all blocks in the current context. The parent of this component determines its context.
  - **Custom - use block list:** Reports on a list of blocks that you specify, and enters the block names in the corresponding field. Specify the full path of each block.

## Object Rows

## Loop Options

Choose block sorting options and reporting options in this pane.

- **Sort blocks:** Use this option to select how to sort blocks (applied to each level in a model):
  - **Alphabetically by block name:** Sorts blocks alphabetically by name.
  - **Alphabetically by system name.** Sorts systems alphabetically. Lists blocks in each system, but in no particular order.

# Requirements Summary Table

---

- Alphabetically by full Simulink path: Sorts blocks alphabetically by Simulink path.
- By block type: Sorts blocks alphabetically by block type.
- By block depth: Sorts blocks by their depth in the model.
- By layout (left to right): Sorts blocks by their location in the model layout, by *rows*. The block appearing the furthest toward the left top corner of the model is the anchor for the row. The row contains all other blocks that overlap the horizontal area defined by the top and bottom edges of the anchor block. The other rows use the same algorithm, using as the anchor the next unreported block nearest the left top of the model.

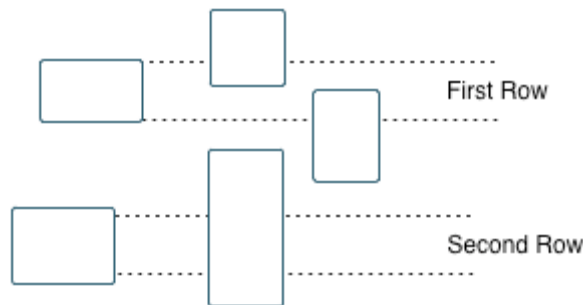

- By layout (top to bottom): Sorts blocks by their location in the model layout, by *columns*. The block appearing the furthest toward the left top corner of the model is the anchor for the column. The column contains all other blocks that overlap the vertical area defined by the left and right edges of the anchor block. The other columns use the same algorithm, using as the anchor the next unreported block nearest the left top of the model.
- By traversal order: Sorts blocks by traversal order.
- By simulation order: Sorts blocks by execution order.
- **Search for Simulink property name/property value pairs:**  
Reports on blocks with specified property name/property value pairs.

# Requirements Summary Table

---

**Insert  
Anything  
into  
Report?**

Yes. Table.

**Class**

RptgenRMI.CSummaryTable

**See Also**

Block Loop, Missing Requirements Block Loop, Missing Requirements System Loop, Requirements Block Loop, Requirements Documents Table, Requirements Signal Loop, Requirements System Loop, Requirements Table

# Requirements System Loop

---

- Purpose** Apply child components to systems with requirements
- Description** This component applies its child components to systems with associated requirements.
- Report On**
- **Loop on systems**
    - **Select systems automatically:** If selected, this option reports on all systems in the current context. The parent of the component determines the context of this setting:
      - **Model Loop:** Reports on systems in the current model.
      - **System Loop:** Reports on the current system.
      - **Signal Loop:** Reports on the parent system of the current signal.
      - **Block Loop:** Reports on the parent system of the current block.
    - If the Requirement System Loop does not have any of these components as its parent, selecting this option reports on all systems with requirements in all models.
    - **Custom - use system list:** Reports on a list of specified systems. Enter the full path of each system.
- Loop Options**
- **Sort Systems:**
    - **Alphabetically by system name (default):** Sorts systems alphabetically by name.
    - **By number of blocks in system:** Sorts systems by the number of blocks in the system. The list displays systems by decreasing number of blocks; the system with the largest number of blocks appears first in the list.
    - **By system depth:** Sorts systems by their depth in the model.
    - **By traversal order:** Sorts systems in the traversal order .

- **Search for:** Reports on Simulink blocks with specified property name/property value pairs.

## Section Options

- **Create section for each object in loop:** Inserts a section in the generated report for each object found in the loop.
- **Display the object type in the section title:** Inserts the object type automatically into the section title in the generated report.
- **Number sections by system hierarchy:** Numbers sections in the generated report hierarchically. Requires that **Sort Systems** be set to By traversal order.
- **Create link anchor for each object in loop:** Creates a hyperlink to the object in the generated report.

## Insert Anything into Report?

Yes, inserts a section if you select the **Create section for each object in loop** option.

## Class

RptgenRMI.CSystemLoop

## See Also

Missing Requirements Block Loop, Missing Requirements System Loop, Requirements Block Loop, Requirements Documents Table, Requirements Signal Loop, Requirements Summary Table, Requirements Table, System Loop

# Requirements Table

---

<b>Purpose</b>	Requirements links for current context
<b>Description</b>	This component creates a table that contains information from the Simulink Verification and Validation software. Objects can have multiple requirements. Each requirement is a row in the table.
<b>Table Options</b>	<ul style="list-style-type: none"><li>• <b>Show requirements for current:</b> Specifies the object type to display.<ul style="list-style-type: none"><li>▪ Simulink object</li><li>▪ Stateflow object</li></ul></li><li>• <b>Table title:</b> Specifies a title for the table.<ul style="list-style-type: none"><li>▪ No title</li><li>▪ Object name (Default)</li><li>▪ Custom</li></ul></li></ul>
<b>Table Columns</b>	<ul style="list-style-type: none"><li>• <b>Description:</b> Includes the object description in the table.</li><li>• <b>Document name:</b> Includes the report name in the table.</li><li>• <b>Locations within document:</b> Includes the locations of the object within the document in the table.</li><li>• <b>Requirement keyword:</b> Includes the requirement keyword for the object in the table.</li></ul>
<b>Insert Anything into Report?</b>	Yes. Table.
<b>Class</b>	RptgenRMI.CReqTable
<b>See Also</b>	Missing Requirements Block Loop, Missing Requirements System Loop, Requirements Block Loop, Requirements Documents



# Requirements Table

---

Table, Requirements Signal Loop, Requirements Summary Table,  
Requirements System Loop, Stateflow Automatic Table, Stateflow  
Name

# Scope Snapshot

---

## Purpose

Insert images of Simulink scopes and XY graphs

## Description

This component inserts images of Simulink scopes and XY graphs. If the model has not been simulated, scopes are empty. For more information, see the [Model Simulation](#) reference page.

The parent component of the Scope Snapshot determines its behavior.

- **Model Loop or no Simulink looping component:** Includes all XY graphs and scopes in the current model.
- **System Loop:** Includes all XY graphs and scopes in the current system.
- **Block Loop:** Includes the current block when it is an XY graph or scope.
- **Signal Loop:** Includes all XY graphs and scopes connected to the current signal.

If the Scope Snapshot does not have any of the Simulink looping components as its parent, it includes all XY graphs and scopes in all open models.

## Scope Options

- **Report on closed scopes:** Takes a snapshot of all scopes in context. This option forces closed scopes to open when the report is generating.
- **Autoscale time axis:** Scales the Simulink scope time axis to include the entire log.

## Print Options

- **Image file format:** Specifies the image file format (for example, JPEG, TIFF, etc.). Select **Automatic HG Format** (the default) to choose the format best suited for the specified output format automatically. Otherwise, choose an image format that your output viewer can read.
  - **Automatic HG Format** (uses the Simulink file format selected in the Preferences dialog box)
  - **Bitmap (16m-color)**

- Bitmap (256-color)
- Black and white encapsulated PostScript
- Black and white encapsulated PostScript (TIFF)
- Black and white encapsulated PostScript2
- Black and white encapsulated PostScript2 (TIFF)
- Black and white PostScript
- Black and white PostScript2
- Color encapsulated PostScript
- Color encapsulated PostScript (TIFF)
- Color encapsulated PostScript2
- Color encapsulated PostScript2 (TIFF)
- Color PostScript
- Color PostScript2
- JPEG high quality image
- JPEG medium quality image
- JPEG low quality image
- PNG 24-bit image
- TIFF - compressed
- TIFF - uncompressed
- Windows metafile
- **Paper orientation:**
  - Landscape
  - Portrait
  - Rotated

# Scope Snapshot

---

- **Use figure orientation:** Uses the orientation for the figure, which you set with the `orient` command.
- **Full page image (PDF only):** In PDF reports, scales images to fit the full page, minimizes page margins, and maximizes the size of the image by using either a portrait or landscape orientation. For more information about paper orientation, see the `orient` reference page in the MATLAB documentation.
- **Image size:** Specifies the size of the Handle Graphics figure snapshot in the form `[w h]` (width, height). In the units text box, select one of the following options:
  - Inches
  - Centimeters
  - Points
  - Normalized
- **Invert hardcopy:** Inverts colors for printing; changes dark colors to light colors and light colors to dark colors.
  - **Automatic:** Automatically changes dark axes colors to light axes colors. If the axes color is a light color, this option does not invert the color.
  - **Invert:** Changes dark axes colors to light axes colors and light axes colors to dark axes colors.
  - **Don't invert:** Does not change the colors in the image on the screen for printing.
  - **Use figure's InvertHardcopy setting:** Uses the `InvertHardcopy` property set in the Handle Graphics image.
  - **Make figure background transparent:** Makes the image background transparent.

## Display Options

- **Scaling:**
  - **Fixed size:** Specifies the number and type of units.

- **Zoom:** Specifies the percentage, maximum size, and units of measure.
- **Use image size:** Causes the image to appear the same size in the report as on screen.
- **Size:** Specifies the size of the snapshot in the form `w h` (width, height). This field is active only if you choose `Fixed size` from the **Scaling** selection list.
- **Max size:** Specifies the maximum size of the snapshot in the form `w h` (width, height). This field is active only if you choose `Zoom` from the **Scaling** selection list.
- **Units:** Specifies the units for the size of the snapshot. This field is active only if you choose `Zoom` or `Fixed size` in the **Image size** list box.
- **Alignment:** Only reports in PDF or RTF format support this property.
  - Auto
  - Right
  - Left
  - Center
- **Title:** Specifies a title for the snapshot figure.
  - **Block name:** Uses the block name as the title.
  - **Full Simulink path name:** Uses the Simulink path as the title.
  - **Custom:** Specifies a custom title.
- **Caption:** Select or enter a short text description for the snapshot figure.
  - No caption
  - **Automatic (use block description).** Uses the Simulink block description as the caption.
  - **Custom.** Specifies a short text description for the snapshot figure.

# Scope Snapshot

---

**Insert  
Anything  
into  
Report?**

Yes. Image.

**Class**

rptgen\_sl.csl\_blk\_scope

**See Also**

Block Loop, Model Loop, Signal Loop, System Loop

## Purpose

Run child components for each signal contained in current system, model, or block

## Description

The Signal Loop component runs its child components for each signal contained in the current system, model, or block. The parent component determines the behavior of this component.

- Model Loop: Loops on all signals in the current model.
- System Loop: Loops on all signals in the current system. Choose not to report on the following types of signals by clearing the corresponding option in the **Section options** area:
  - System input signals
  - System output signals
  - System internal signals
- Signal Loop: Loops on the current signal.
- Block Loop : Loops on all signals connected to the current block. Choose not to report on the following types of signals by clearing the corresponding option in the **Section options** area:
  - Block input signals
  - Block output signals
- If the Signal Loop does not have a looping component as its parent, it loops on all signals in all models. Choose not to report on the following types of signals by clearing the corresponding option in the **Section options** area:
  - Block input signals
  - Block output signals
  - System input signals
  - System output signals
  - System internal signals

# Signal Loop

---

## Select Signals

- **Include block input signals:** Loops on signals that feed into blocks. This option is valid only when the parent component of this component is aBlock Loop.
- **Include block output signals:** Loops on signals that leave the block. This option is valid only when the parent component of this component is aBlock Loop.
- **Include system input signals:** Loops on signals coming from inports. This option is valid only when the parent component of this component is aSystem Loop.
- **Include system internal signals:** Loops on system internal signals. This option is valid only when the parent component of this component is aSystem Loop.
- **Include system output signals:** Loops on signals going to outports. This option is valid only when the parent component of this component is aSystem Loop.
- **Sort signals:** Specifies how to sort signals:
  - Alphabetically by signal name: Sorts signals alphabetically by name.
  - Alphabetically by signal name (exclude empty): Sorts signals alphabetically by name.
  - Alphabetically by system name: Sorts alphabetically by parent system names. Lists signals in each system, but in no particular order.
  - By signal depth: Sorts signals by their depth in the model.

## Section Options

- **Create section for each object in loop:** Inserts a section in the generated report for each object found in the loop.
- **Display the object type in the section title:** Automatically inserts the object type into the section title in the generated report.
- **Create link anchor for each object in loop:** Creates a hyperlink to the object in the generated report.



**Insert  
Anything  
into  
Report?**

Yes, inserts a section if you select the **Create section for each object in loop** option.

**Class**

rptgen\_sl.csl\_sig\_loop

**See Also**

Block Loop, Model Loop, System Loop

# Simulink Automatic Table

---

**Purpose** Insert two-column table with information on selected model, system, signal, or block

**Description** This component inserts a two-column table that contains details for the selected model, system, signal, or block into a generated report.

- Options**
- **Show current:** Includes a specified Simulink software feature in the generated report.
    - **Automatic:** Uses the context of the parent loop.
    - **Model**
    - **System**
    - **Block**
    - **Annotation**
    - **Signal**
  - **Properties list:** Specifies whether to select properties manually or automatically.
    - **Determine properties automatically:** Uses blocks and dialog box properties.
    - **Show properties:** Enables you to specify properties manually.
  - **Show full path name:** Displays the full path of the selected Simulink model.
  - **Display property names as prompts:** Displays property names as prompts in the generated report. The report includes the dialog box string instead of the underlying code property.

- Display Options**
- **Table title:** Displays a table title in the generated report.
    - **Name:** Automatically generates a title from the parameter.
    - **Custom:** Specifies a custom title.
    - **No title:** Does not include a title.

- **Header row:** Select a header row for the table in the generated report.
  - No header: Includes no header row.
  - Type and Name: Includes a header row with columns for name and object type.
  - Custom: Includes a custom header.
- **Don't display empty values:** Excludes empty parameters in the generated report.

## **Insert Anything into Report?**

Yes. Table.

## **Class**

rptgen\_sl.csl\_auto\_table

## **See Also**

Block Loop, Model Loop, Signal Loop, System Loop

# Simulink Dialog Snapshot

---

## Purpose

Insert snapshots of Simulink editor dialog boxes

## Description

This component takes snapshots of Simulink editor dialog boxes. You use it to display the current settings associated with an object or document the appearance of your custom mask dialog boxes.

The parent component of this component determines the behavior of this component.

- **Block Loop:** Documents the dialog box of the current reported block.
- **System Loop:** Documents the dialog box of the current reported system.

## Format

- **Image file format:** Specifies the format for the snapshot image file. The **automatic** format chooses **BMP** format for PDF files, and **PNG** for other formats.
- **Show all tabs:** Automatically generates images for all the tabs for the dialog box. If you clear this check box, Simulink Report Generator creates an image of only the first tab.

## Display Options

- **Scaling:**
  - **Fixed size:** Specifies the number and type of units.
  - **Zoom:** Specifies the percentage, maximum size, and units of measure.
  - **Use image size:** Causes the image to appear the same size in the report as on screen.
- **Size:** Specifies the size of the snapshot in the format **w h** (width, height). This field is active only if you choose **Fixed size** from the **Scaling** selection list.
- **Max size:** Specifies the maximum size of the snapshot in the format **w h** (width, height). This field is active only if you choose **Zoom** from the **Scaling** selection list.

- **Units:** Specifies the units for the size of the snapshot. This field is active only if you choose Zoom or Fixed size in the **Image size** list box.
- **Alignment:** Only reports in PDF or RTF format support this property.
  - Auto
  - Right
  - Left
  - Center
- **Title:** Specifies text to appear above the snapshot.
- **Caption:** Specifies text to appear under the snapshot.

## Insert Anything into Report?

Yes. Snapshot.

## Class

rptgen\_sl.CDialogSnapshot

## See Also

Block Loop, System Loop

# Simulink Function System Loop

---

## Purpose

Report on Simulink functions specified in a Stateflow loop

## Description

This component runs its child components for each Simulink function system defined by the parent component. For example, to include Simulink functions within a given model in the report, you can include this component as the child of a Stateflow Object Loop or Object Loop component, each of which in turn is usually a child of a Chart Loop component.

## Report On

**Include subsystems in nested Simulink functions:** Specifies whether to include subsystems in nested Simulink functions. By default, this option is enabled.

## Loop Options

- **Sort Systems:** Specifies how to sort systems.
  - **Alphabetically by system name (default):** Sorts systems alphabetically by name.
  - **By number of blocks in system:** Sorts systems by number of blocks. The list shows systems by decreasing number of blocks; that is, the system with the largest number of blocks appears first in the list.
  - **By system depth:** Sorts systems by their depth in the model.
  - **By traversal order:** Sorts systems in traversal order.
- **Search for:** Reports only on Subsystem blocks with the specified property name/property value pairs. To enable searching, click the check box. In the first row of the property name and property value table, click inside the edit box, delete the existing text, and type the property name and value.

For information about subsystem property names and values, in “Block-Specific Parameters”, see the “Ports & Subsystems Library Block Parameters” section.

## Section Options

- **Create section for each object in loop:** Inserts a section in the generated report for each object found in the loop.
- **Display the object type in the section title:** Inserts the object type automatically into the section title in the generated report.
- **Number sections by system hierarchy:** Hierarchically numbers sections in the generated report. Requires that **Sort Systems** be set to **By traversal order**.
- **Create link anchor for each object in loop:** Creates a hyperlink to the object in the generated report.

## Insert Anything into Report?

Yes, inserts a section if you select the **Create section for each object in loop** option.

## Class

rptgen\_sl.csl\_sys\_loop

## See Also

Object Loop, State Loop, Chart Loop, System Loop, Block Loop, Model Loop, Signal Loop

# Simulink Functions and Variables

---

**Purpose** Create table that displays workspace variables and MATLAB functions used by reported blocks in Simulink models

**Description** This component creates a table that displays workspace variables and MATLAB functions used by blocks in a Simulink model. The **Model Loop** component specifies the current model and systems in which the blocks appear. For example, suppose a Simulink **Gain** block has a string `cos(x)` instead of a number. The Simulink software looks for a variable `x` in the workspace and uses the `cos` function.

**Functions**

- **Include table of functions:** Includes a table of Simulink functions in the generated report.
- **Table Title:** Specifies a title for the table in the generated report:
  - **Automatic:** Generates a title automatically from the parameter.
  - **Custom:** Specifies a custom title.
- **Parent block:** Includes a column in the table that includes the name of the block, which contains the reported variable.
- **Calling string:** Includes the MATLAB code that calls the reported variable.
- **Include fixed-point functions (sfix, ufix, ...):** Includes Fixed-Point Toolbox™ functions in the report.

**Variables**

- **Include table of variables:** Includes a table of Simulink variables in the generated report.
- **Table title:** Specifies a title for the table in the generated report.
  - **Automatic:** Generates a title automatically from the parameter.
  - **Custom:** Specifies a custom title.
- **Include Workspace I/O parameters:** Reports on variables that contain parameters with time vectors and state matrices. Set these parameters in the **Workspace I/O** pane in the Simulation Parameters dialog box in a Simulink model.



# Simulink Functions and Variables

In the following table, if any of the entries in the first column are on, the component looks for the variable listed in the second column. If the component finds the variable in the workspace, it includes it in the report.

Parameter name	Variable name
LoadExternalInput	ExternalInput
SaveTime	TimeSaveName
SaveState	StateSaveName
SaveOutput	OutputSaveName
LoadInitialState	InitialState
SaveFinalState	FinalStateName

- **Parent block:** Includes the name of the block that contains the reported variable.
- **Calling string:** Includes the MATLAB code that calls the reported variable.
- **Size of variable:** Includes the size of the reported variable.
- **Class of variable:** Includes the variable class to which the reported variable belongs.
- **Memory size:** Includes the amount of memory in bytes that the reported variable needs.
- **Value in workspace:** Includes the value of the reported variable.

Large arrays may appear as [MxN CLASS]. For example, if you have a 300-by-200 double array, it appears in the report as [300x200 DOUBLE].

- **Storage class:** Include the storage class of the reported variable.

The title of this column is **Storage Class**. This option looks at the model's `TunableVars` property to see if any of the model variables specify their storage class. If you specify the storage class,

# Simulink Functions and Variables

---

TunableVarsStorageClass and TunableVarsTypeQualifier appear in a table column in the model variables table.

The column entries are TunableVarsStorageClass (TunableVarsTypeQualifier) when TunableVarsTypeQualifier is not empty. If TunableVarsTypeQualifier is empty, the column entry is TunableVarsStorageClass.

Values for TunableVarsStorageClass include:

- Exported Global
  - Auto
  - ImportedExtern
  - ImportedExtern Pointer
- **Data object properties:** Reports on data object properties.

## Example

This table is an example of a table created by the Model Variables component. This Property Table reports on the variables in the Controller in the F14 model.

Variable Name	Parent Blocks	Calling String	Value
Ka	f14/Controller/Gain3	Ka	0.677
Kf	f14/Controller/Gain	Kf	-1.746
Ki	f14/Controller/Proportional plus integral compensator	[Ki]	-3.864
Kq	f14/Controller/Gain2	Kq	0.8156

**Insert  
Anything  
into  
Report?**

Yes. Table.

**Class**

rptgen\_sl.csl\_obj\_fun\_var

**See Also**

Block Loop, Model Loop, Signal Loop, System Loop

# Simulink Library Information

---

**Purpose** Insert table that lists library links in the current model, system, or block

**Description** This component inserts a table that lists library links in the current model, system, or block.

## Table Columns

- **Block:** Includes the Simulink block name in the generated table.
- **Library:** Includes the Simulink library root name in the generated table.
- **Reference block:** Includes the Simulink reference block name in the generated table.
- **Link status:** Includes the link status in the generated table.

## Display Options

- **Title:** Specifies a title for the generated report.
- **Sort table by:**
  - **Block:** Sorts the table by block name.
  - **Library:** Sorts the table by library name.
  - **Reference Block:** Sorts the table by reference block name.
  - **Link Status:** Sorts the table by link status.
- **Merge repeated rows:** Merges sorted rows in the generated table.

## Example

The following table sorts based on Reference Block column. The Report Explorer uses the `aero_guidance` model with **Merge repeated rows** deselected to generate the table.

Block	Library	Reference Block	Status
Equations of Motion (Body Axes)	Aerospace	Equations of Motion (Body Axes)	resolved
Incidence & Airspeed	Aerospace	Incidence & Airspeed	resolved

# Simulink Library Information

Block	Library	Reference Block	Status
Fin Actuator	Aerospace	2nd Order Nonlinear Actuator	resolved
3DoF Animation	Aerospace	3DoF Animation	resolved
Atmosphere	Aerospace	Atmosphere model	resolved
Cm	Simulink	Interpolation (n-D) using PreLookup	resolved
Cx	Simulink	Interpolation (n-D) using PreLookup	resolved
Cz	Simulink	Interpolation (n-D) using PreLookup	resolved
Kg	Simulink	Interpolation (n-D) using PreLookup	resolved
Ki	Simulink	Interpolation (n-D) using PreLookup	resolved
Alpha Index	Simulink	PreLookup Index Search	resolved
Mach Index	Simulink	PreLookup Index Search	resolved
Mach Index	Simulink	PreLookup Index Search	resolved
Alpha  Index	Simulink	PreLookup Index Search	resolved

When you select **Merge repeated rows**, the generated table collapses rows in the **Block** column. Each row in the **Reference Block** column is unique, as shown in the following table.

# Simulink Library Information

Block	Library	Reference Block	Status
Equations of Motion (Body Axes)	Aerospace	Equations of Motion (Body Axes)	resolved
Incidence & Airspeed	Aerospace	Incidence & Airspeed	resolved
Fin Actuator	Aerospace	2nd Order Nonlinear Actuator	resolved
3DoF Animation	Aerospace	3DoF Animation	resolved
Atmosphere	Aerospace	Atmosphere model	resolved
Cm Cx Cz Kg Ki	Simulink	Interpolation (n-D) using PreLookup	resolved
Alpha Index Mach Index Mach Index   Alpha   Index	Simulink	PreLookup Index Search	resolved

Yes. Table.

**Insert  
Anything  
Into  
Report?**

**Class** rptgen\_sl.CLibinfo

**See Also** Block Loop, Model Loop, System Loop

# Simulink Linking Anchor

---

## Purpose

Designate locations to which links point

## Description

This component designates a location to which links point. Use the `Model Loop`, `System Loop`, `Block Loop`, or `Signal Loop` component as the parent component for this component.

## Properties

- **Insert text:** Specifies text to appear after the linking anchor.
- **Link from current:** Sets the current model, system, block, or signal as the linking anchor.
  - **Automatic:** Automatically selects the appropriate model, system, block, or signal as a linking anchor. If the `Model Loop` component is the parent component, the linking anchor is set on the current model. Similarly, if the `Block Loop` or `Signal Loop` is the parent component, the linking anchor is inserted for the current system, block, or signal, respectively.
  - **Model:** Sets the linking anchor to the current model.
  - **System:** Sets the linking anchor to the current system.
  - **Block:** Sets the linking anchor to the current block.
  - **Annotation:** Sets the linking anchor to the current annotation.
  - **Signal:** Sets the linking anchor to the current signal.

---

**Note** Use only one anchor per report each object. For more information, see the `Simulink Summary Table` component reference page.

---

## Insert Anything into Report?

Yes. A link, and possibly text, depending on attribute choices.



**Class** rptgen\_sl.cs1\_obj\_anchor

**See Also** Block Loop, Model Loop, Signal Loop, System Loop

# Simulink Name

---

**Purpose** Insert name of a Simulink model, system, block, or signal into report

**Description** This component inserts the name of a Simulink model, system, block, or signal into the report.

Using this component as the first child component of a Chapter/Subsection component allows the current Simulink model, system block, or signal name to be the chapter or section title.

## Properties

- **Object type**
  - **Automatic:** Automatically selects the appropriate model, system, block, or signal name as the Simulink object name to include in the report. If the Model Loop component is the parent component, the object name is the current model name. If the System Loop, Block Loop, or Signal Loop is the parent component, then the object name is the name of the current system, block, or signal, respectively.
  - **Model:** Includes the current model name in the report.
  - **System:** Includes the current system name in the report.
  - **Block:** Includes the current block name in the report.
  - **Signal:** Includes the current signal name in the report. If the signal name is empty, the signal <handle>, which is a unique numerical identifier to that signal, appears in the report.
  - **Annotation:** Includes the current annotation name in the report.
- **Display name as:** Display the Simulink object name in the report.
  - **Name:** For example, f14
  - **Type Name:** For example, Model f14
  - **Type - Name:** For example, Model - f14
  - **Type: Name:** For example, Model: f14
- **Show full path name:** Displays the full path of a system or block. Choosing this option for a block causes the Simulink block name to appear as <Model Name>/<System Name>/<Block Name>.

---

**Note** This option is not available for models or signals.

---

**Insert  
Anything  
into  
Report?**

Yes. Text.

**Class**

rptgen\_sl.csl\_obj\_name

**See Also**

Chapter/Subsection

# Simulink Property

---

**Purpose** Insert property name/property value pair for current Simulink model, system, block, or signal

**Description** This component inserts a single property name/property value pair for the current Simulink model, system, block, or signal.

## Simulink Object and Parameter

- **Object type:** Specifies the Simulink object type to include in the report.
  - System
  - Model
  - Block
  - Signal
  - Annotation
- **System parameter name:** Specifies a Simulink parameter name to include in the generated report:
  - If you select Model for **Object type**, this option appears as **Model parameter name**.
  - If you select Block for **Object type**, this option appears as **Block parameter name**.
  - If you select Signal for **Object type**, this option appears as **Signal parameter name**.

## Display Options

- **Title:** Choose a title to display in the generated report:
  - Automatic: Uses the parameter name as the title.
  - Custom: Specifies a custom title.
  - None: Uses no title.
- **Size limit:** Limits the width of the display in the generated report. Units are in pixels. The size limit for a given table is equal to the hypotenuse of the table width and height [ $\sqrt{w^2+h^2}$ ]. The size limit for text is the number of characters squared. If you exceed the

size limit, the variable appears in condensed form. Setting a size limit of zero always causes the variable to display, regardless of its size

- **Display as:** Specifies a display style.
  - **Auto table/paragraph:** Displays as a table or paragraph based on the information.
  - **Table:** Displays as a table.
  - **Paragraph:** Displays as a text paragraph.
  - **Inline text:** Displays as inline, which fits in line with the surrounding text.
- **Ignore if value is empty:** If the parameter is empty, the report excludes the parameter from the generated report.

## Insert Anything into Report?

Yes. Text.

## Class

rptgen\_sl.csl\_property

## See Also

Block Loop, Model Loop, System Loop

# Simulink Property Table

---

**Purpose** Insert table that reports on model-level property name/property value pairs

**Description** This component inserts a table that reports on model-level property name/property value pairs.

**Properties** **Select Object:** Choose the object for the Property Table in the generated report.

- Model
- System
- Block
- Signal
- Annotation

For more information about selecting object types in Property Table components, see “Select Object Types” on page 6-9.

**Table** Select a preset table, which is already formatted and set up, in the preset table list in the upper-left corner of the attributes page.

- **Preset table:** Specifies the type of the object property table.
  - Default
  - Simulation parameters
  - Version information
  - Simulink Coder information
  - Summary (req. Simulink Coder)
  - Blank 4x4

To apply a preset table, select the table and click **Apply**.

- **Split property/value cells:** Split property name/property value pairs into separate cells. For the property name and property value to

appear in adjacent horizontal cells, select the **Split property/value cells** check box. In this case, the table is in split mode, so there is only one property name/property value pair per cell. If there is more than one name/property pair in a cell, only the first pair appears in the report. All subsequent pairs are ignored.

For the property name and property value to appear together in one cell, clear the **Split property/value cells** check box. That setting specifies nonsplit mode. Nonsplit mode supports more than one property name/property value pair and text per cell.

Before switching from nonsplit mode to split mode, make sure that there is only one property name/property value pair per table cell. If there is more than one property name/property value pair or text per cell, only the first property name/property value pair appears in the report. The report omits subsequent pairs and text.

- **Display outer border:** Displays the outer border of the table in the generated report.
- **Table Cells:** Specifies table properties to modify. The selection in this pane affects available fields in the **Cell Properties** pane.

## Cell Properties

The options in this pane depend on the object selected in the **Table Cells** pane. If you select %<Name> Information, only **Contents** and **Show** appear. If you select any other object in the **Table Cells** pane, **Lower border** and **Right border** display.

- **Contents:** Enables you to change the contents of the table cell selected in the **Table Cells** pane.
- **Show as:** Specifies the format for the contents of the table cell.
  - Value
  - Property Value
  - PROPERTY Value
  - Property: Value
  - PROPERTY: Value

# Simulink Property Table

---

- Property - Value
- PROPERTY - Value
- **Alignment:** Specifies the alignment of the contents of the selected table cell in the **Table Cells** pane.
  - Left
  - Center
  - Right
  - Double justified
- **Lower border:** Displays the lower border of the table in the generated report.
- **Right border:** Displays the right border of the table in the generated report.

## Creating Custom Tables

To create a custom table, edit a preset table, such as the **Blank 4x4** table. Add and delete rows and add properties. To open the Edit Table dialog box, click **Edit**.

For more information on creating custom property tables, see “Property Table Components” on page 6-6.

If the Simulink Coder software is not installed, **Summary** (req Simulink Coder) does not appear in this list. If you are using a report setup file that contains a summary property, the property name appears in the report, but the property value does not.

## Example

The following report displays information on the F14 model using the **Simulation Parameters** preset table.

<i>Solver</i> ode45	<i>ZeroCross</i> on	<i>StartTime</i> 0.0 <i>StopTime</i> 60
<i>RelTol</i> 1e-4	<i>AbsTol</i> 1e-6	<i>Refine</i> 1



# Simulink Property Table

---

<i>InitialStep</i> auto	<i>FixedStep</i> auto	<i>MaxStep</i> auto
<i>LimitMaxRows</i> off	<i>MaxRows</i> 1000	<i>Decimation</i> 1

## **Insert Anything into Report?**

Yes. Table.

## **Class**

rptgen\_sl.csl\_prop\_table

## **See Also**

Model Loop, Signal Loop, System Loop

# Simulink Sample Time

---

<b>Purpose</b>	Insert title of Simulink sample time into report
<b>Description</b>	This component inserts a title for a Simulink sample time into the report.
<b>Properties</b>	<ul style="list-style-type: none"><li>• <b>Table Options</b><ul style="list-style-type: none"><li>▪ <b>Title:</b> Specifies a title for the table in the generated report.</li><li>▪ <b>Grid lines:</b> Show grid lines for the table.</li></ul></li></ul>
<b>Insert Anything into Report?</b>	Yes. Table.
<b>Class</b>	rptgen_sl.CSampleTime
<b>See Also</b>	Chapter/Subsection

<b>Purpose</b>	Properties or parameters of specified Simulink models, systems, blocks, or signals in table
<b>Description</b>	This component displays properties or parameters of selected Simulink models, systems, blocks, or signals in a table.
<b>Object type</b>	<p>Choose the object type to display in the generated report.</p> <ul style="list-style-type: none"><li>• Block (Default)</li><li>• Model</li><li>• System</li><li>• Signal</li><li>• Annotation</li></ul> <p>The selected object type affects the options available in the <b>Property Columns</b> pane.</p>
<b>Table title</b>	<p>Choose a title to appear in the generated report:</p> <ul style="list-style-type: none"><li>• Automatic: Automatically generates a title from the parameter.</li><li>• Custom: Specifies a custom title.</li></ul>
<b>Property Columns</b>	<p>This pane displays object properties to include in the Summary Table in the generated report.</p> <ul style="list-style-type: none"><li>• To add a property:<ol style="list-style-type: none"><li>1 select the appropriate property level in the text box on the left.</li><li>2 In the text box on the right, select the property that you want to add and click <b>Add</b>.</li></ol></li><li>• To delete a property, select the property name and click <b>Delete</b>.</li></ul>

# Simulink Summary Table

---

`%<SplitDialogParameters>` is a unique property for Simulink Summary Tables, where the object type is `Block`. This property generates multiple summary tables, organized by block type. Each Summary Table group contains the dialog box parameters for that block.

Some entries in the list of available properties (such as `Depth`) are “virtual” properties that you cannot access using the `get_param` command. The properties used for property/value filtering in the block and System Loop components must be retrievable by the `get_param`. Therefore, you cannot configure your Summary Table to report on all blocks of `Depth == 2`.

You can create multiple values for a property in a Simulink Summary Table. For example, to report on blocks of type `Inport`, `Outport` and `Constant`:

- 1 Check the **Search for Simulink property name/property value pairs** box.
- 2 Make sure that you set **Property Name** to `BlockType`.
- 3 Type the following text into the **Property Value** field:

```
\<(Inport|Outport|Constant)\>
```

**Remove empty columns:** Removes empty columns from the table.

**Transpose table:** Changes the summary table rows into columns in the generated report, putting the property names in the first column and the values in the other columns.

## Object Rows

- **Insert anchor for each row:** Inserts an anchor for each row in the summary table.
- **Report On:**
  - **Automatic list from context:** Reports on all blocks in the current context, as set by the parent component.

## Loop Options

- Custom - use block list: Reports on a list of specified blocks. Specify the full path of each block.

- Sort blocks

- Alphabetically by block name: Sorts blocks alphabetically by name.
- Alphabetically by system name: Sorts systems alphabetically by name. Lists blocks in each system, but in no particular order.
- Alphabetically by full Simulink path: Sorts blocks alphabetically by Simulink path.
- By block type: Sorts blocks alphabetically by block type.
- By block depth: Sorts blocks by their depth in the model.
- By layout (left to right): Sorts blocks by their location in the model layout, by *rows*. The block appearing the furthest toward the left top corner of the model is the anchor for the row. The row contains all other blocks that overlap the horizontal area defined by the top and bottom edges of the anchor block. The other rows use the same algorithm, using as the anchor the next unreported block nearest the left top of the model.

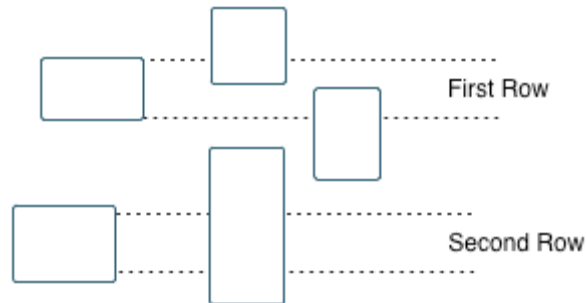

- By layout (top to bottom): Sorts blocks by their location in the model layout, by *columns*. The block appearing the furthest toward the left top corner of the model is the anchor for the column. The

# Simulink Summary Table

column contains all other blocks that overlap the vertical area defined by the left and right edges of the anchor block. The other columns use the same algorithm, using as the anchor the next unreported block nearest the left top of the model.

- By traversal order: Sorts blocks by traversal order.
- By simulation order: Sorts blocks by execution order.
- %<VariableName>: Inserts the value of a variable from the MATLAB workspace. The %<> notation can denote a string or cell array. For more information, see %<VariableName> Notation on the Text component reference page.
- **Search for Simulink property name/property value pairs:**  
Reports on blocks with specified property name/property value pairs.

## Example

Specify the following options to generate a Summary Table in a report for on the model F14:

- Sort on systems by system depth.
- Include the system parameters Name and Block in the table.

The following table appears in the report.

Name	Blocks
f14	u, Actuator Model, Aircraft Dynamics Model, Angle of Attack, Controller, Dryden Wind Gust Models, Gain, Gain1, Gain2, Gain5, More Info, More Info1, Nz pilot calculation, Pilot, Pilot G force Scope, Stick Input, Sum, Sum1, alpha (rad), Nz Pilot (g)
Aircraft Dynamics Model	Elevator Deflection d (deg), Vertical Gust wGust (ft/sec), Rotary Gust qGust (rad/sec), Gain3, Gain4, Gain5, Gain6, Sum1, Sum2, Transfer Fcn.1,

# Simulink Summary Table

Name	Blocks
	Transfer Fcn.2, Vertical Velocity w (ft/s), Pitch Rate q (rad/s)
Controller	Stick Input (in), alpha (rad), q (rad/s), Alpha-sensor Low-pass Filter, Gain, Gain2, Gain3, Pitch Rate Lead Filter, Proportional plus integral compensator, Stick Prefilter, Sum, Sum1, Sum2, Elevator Command (deg)
Dryden Wind Gust Models	Band-Limited White Noise, Q-gust model, W-gust model, Wg, Qg
More Info	None
More Info1	None
Nz pilot calculation	w, q, Constant, Derivative, Derivative1, Gain1, Gain2, Product, Sum1, Pilot g force (g)

## Insert Anything into Report?

Yes. Table.

## Class

rptgen\_sl.csl\_summ\_table

## See Also

Block Loop, Model Loop, Signal Loop, System Loop  
Simulink Function System Loop

# Simulink Workspace Variable

---

**Purpose** Report information about MATLAB and model workspace variables that model uses

**Description** This component provides information about variables in the MATLAB (base) workspace and the model workspaces that a model uses. The report includes the value of each variable. Optionally, you can include the following information for each variable:

- Workspace where the variable is located
- Blocks that use the variable

For variables that are Simulink data objects (for example, a `Simulink.Parameter` object), the report includes the properties of the object. You can filter out properties to streamline the report.

**Options** The following two options specify additional information that the report can include about each variable:

- **Show workspace:** Report whether each variable is in the MATLAB workspace or in a model workspace.
- **Show blocks that use variable:** Report the blocks that use each variable.

For variables whose values are Simulink data objects, you can filter which properties to include in the report, using one of the following approaches:

- Use the **Filter Properties** area of the dialog box to specify a standard filter.

The standard filter options apply to all variables whose values are instances of the class or classes that you specify. For example, you can use a standard filter to filter out the `Description` property for all variables used by the model whose values use a `Simulink.Parameter` object.



- Select the **Use custom property filter** option and write MATLAB code for filtering.

Writing custom filtering code allows you to do kinds of filtering that the standard filter does not perform. Some common examples of custom filters that you might want to create are filters that filter out:

- A property for some, but not all, instances of a class
- Properties that match a regular expression

The **Filter Properties** area of the dialog box, where you specify a standard filter, has these fields:

- **Class name (\* for all classes)**: Specify the class of the variables for which you want to filter out specific properties. You can specify one class at a time, or enter an asterisk (\*) to specify all classes. After you enter the class name, move the cursor outside of the edit box.
- **Available Properties**: If the class that you entered in **Class name (\* for all classes)** is on the MATLAB path, then this list displays the properties of that class.
- **Filtered Properties**: Displays the properties to filter out. Use the right-arrow button to add to the **Filtered Properties** list the properties that you selected in the **Available Properties** list.
- If the class that you enter is *not* on the MATLAB path, then a **Comma-separated list of properties to be filtered** edit box appears. Enter the names of properties to use for filtering.
- **Convert to Custom**: Generate custom MATLAB code that implements your **Filter Properties** standard filter settings.

---

**Note** Selecting the **Convert to Custom** button overwrites any existing MATLAB custom filtering code for this component.

---

# Simulink Workspace Variable

---

To create and apply custom filtering MATLAB code, select the **Use custom property filter** check box. Selecting this check box opens an edit box where you define a MATLAB function for filtering properties. The edit box includes a sample function (commented out) that you can use as a starting point for your filtering function. Use the `isFiltered` variable for the output of your function. For example:

- To filter out the Owner and testProp properties, in the edit box enter:

```
isFiltered = strcmpi(propertyName, 'Owner') || ...
            strcmpi(propertyName, 'testProp');
```

- To filter out all properties *except* for the CoderInfo property, in the edit box, enter:

```
isFiltered = ~strcmpi(propertyName, 'CoderInfo');
```

If you clear the **Use custom property filter** check box, Simulink Report Generator saves your custom MATLAB filtering code, but does not use that code to filter properties.

## Insert Anything into Report?

Yes. List.

## Class

rptgen\_sl.csl\_ws\_variable

## See Also

Simulink Workspace Variable Loop, Bus, Simulink Functions and Variables

# Simulink Workspace Variable Loop

---

<b>Purpose</b>	Reports on Simulink workspace variable objects
<b>Description</b>	This component displays all variables in the Simulink workspace (base workspace and model workspaces). You can limit the variables displayed to those variables that match property name and property value pairs that you specify.
<b>Loop Options</b>	<ul style="list-style-type: none"><li>• <b>Sort</b><ul style="list-style-type: none"><li>▪ <b>Alphabetically by text:</b> Sorts variables alphabetically by name.</li><li>▪ <b>By data type:</b> Sorts variables alphabetically by data type.</li></ul></li><li>• <b>Search for Simulink property name/property value pairs:</b> Reports on variables with specified property name/property value pairs.</li></ul>
<b>Section Options</b>	<ul style="list-style-type: none"><li>• <b>Create section for each object in loop:</b> Creates a separate section in the output for each variable.<ul style="list-style-type: none"><li>▪ If you specify to create a section for each variable, you can select the <b>Display the object type in the section title</b> to insert a variable name in each section title.</li></ul></li><li>• <b>Create link anchor for each object in loop:</b> Specifies a custom title.</li></ul>
<b>Insert Anything into Report?</b>	Yes, inserts sections if you select the <b>Create section for each object in loop</b> option
<b>Class</b>	rptgen_sl.csl_ws_var_loop
<b>See Also</b>	Simulink Workspace Variable, Bus, Simulink Functions and Variables

# State Loop

---

## Purpose

Run child components for all states in current context

## Description

This component runs its children for all states in its context. The parent component of this component determines the context.

- **Model Loop:** Includes all states in the models.
- **System Loop:** Includes all states in the systems.
- **Machine Loop:** Includes all states in the machines.
- **Chart Loop:** Includes all states in the charts.
- **State Loop:** Includes all states in the current state.

## State Types

- **Include “and” and “or” states:** Includes AND and OR states in the loop.
- **Include “box” states:** Includes “box” states in the loop.
- **Include functions:** Includes “function” states in the loop.
- **Include truth tables:** Includes truth tables in the loop.
- **Include MATLAB functions:** Includes MATLAB functions in the loop.

## Loop Options

- **Report depth:** Specifies the level on which to loop.
  - Local children only
  - All objects
- **Skip autogenerated charts under truth table:** Keeps autogenerated state objects under truth tables from appearing in the report.
- **Search Stateflow:** Indicates specific states to include in the loop.

## Section Options

- **Create section for each object in loop:** Inserts a section in the generated report for each object found in the loop.
- **Display the object type in the section title:** Inserts the object type automatically into the section title in the generated report.
- **Create link anchor for each object in loop:** Creates a hyperlink to the object in the generated report.

## Insert Anything into Report?

Yes, section, if you select the **Create section for each object in loop** option.

## Class

rptgen\_sf.csf\_state\_loop

## See Also

Chart Loop, Machine Loop, Model Loop, State Loop, System Loop, Simulink Function System Loop

# Stateflow Automatic Table

---

## Purpose

Insert table with properties of current Stateflow object

## Description

The Stateflow Automatic Table component inserts a table that contains the properties of the current Stateflow object. Parents of this component can be:

- Machine Loop
- State Loop
- Chart Loop
- Graphics Object Loop

## Display Options

- **Table title:** Specifies a title for the table in the generated report.
  - No title: Includes no title.
  - Custom: Includes a custom title.
  - Name (default): Uses an object name as the title.
    - Object name
    - Object name with Stateflow path
    - Object name with Simulink and Stateflow path
- **Header row:** Selects a header row for the table in the generated report.
  - No header: Includes no header row.
  - Type and Name: Includes a header row with columns for name and object type. When selected, this option creates a header row for the table with object name and type.
  - Custom: Includes a custom header.
- **Don't display empty values:** Excludes empty values from the generated report.

**Insert  
Anything  
into  
Report?**

Yes. Table.

**Class**

rptgen\_sf.csf\_auto\_table

**See Also**

Chart Loop, Graphics Object Loop, Machine Loop, State Loop

# Stateflow Count

---

<b>Purpose</b>	Count number of Stateflow objects in current context
<b>Description</b>	This component counts the number of Stateflow objects in the current context.
<b>Properties</b>	<ul style="list-style-type: none"><li>• <b>Search depth:</b> Specifies the search depth for the count.<ul style="list-style-type: none"><li>▪ Immediate children only (default): Searches only children one level under the Stateflow object.</li><li>▪ All descendants: Searches all children of the Stateflow object.</li></ul></li><li>• <b>Sort results:</b> Specifies the sort method for the count results.<ul style="list-style-type: none"><li>▪ Numerically decreasing by object count (Default)</li><li>▪ Alphabetically increasing by object type</li></ul></li><li>• <b>Include a list of objects in table:</b> Inserts a column containing the counted objects.</li><li>• <b>Show total count:</b> Displays a total of counted objects.</li></ul>
<b>Insert Anything into Report?</b>	Yes. Table.
<b>Class</b>	rptgen_sf.csf_count
<b>See Also</b>	State Loop



<b>Purpose</b>	Insert snapshots of Stateflow editor dialog boxes
<b>Description</b>	This component reports on the current reported Stateflow dialog box object, depending on its context. If this component is the child of a State Loop, for example, the report includes information about the dialog box of the current State. Display the current settings associated with an object or document the appearance of your custom mask dialog boxes.
<b>Format</b>	<ul style="list-style-type: none"><li>• <b>Image file format:</b> Specifies the format for the snapshot image file. The Automatic format uses BMP format for PDF files and PNG for other formats.</li><li>• <b>Show all tabs:</b> Automatically generates images for all the tabs for the dialog box. If you clear this check box, the Simulink Report Generator software creates an image of only the first tab.</li></ul>
<b>Display Options</b>	<ul style="list-style-type: none"><li>• <b>Scaling:</b><ul style="list-style-type: none"><li>▪ <b>Fixed size:</b> Specifies the number and type of units.</li><li>▪ <b>Zoom:</b> Specifies the percentage, maximum size, and units of measure.</li><li>▪ <b>Use image size:</b> Causes the image to appear the same size in the report as on screen.</li></ul></li><li>• <b>Size:</b> Specifies the size of the snapshot in the form w h (width, height). This field is active only if you choose <b>Fixed size</b> in the <b>Scaling</b> selection list.</li><li>• <b>Max size:</b> Specifies the maximum size of the snapshot in the form w h (width, height). This field is active only if you choose <b>Zoom</b> in the <b>Scaling</b> selection list.</li><li>• <b>Units:</b> Specifies the units for the size of the snapshot. This field is active only if you choose <b>Zoom</b> or <b>Fixed size</b> in the <b>Image size</b> list box.</li><li>• <b>Alignment:</b> Aligns your snapshot. Only reports in PDF or RTF format support this property.</li></ul>

# Stateflow Dialog Snapshot

---

- Auto
- Right
- Center
- Left
- **Title:** Specifies text to appear above the snapshot.
- **Caption:** Specifies text to appear under the snapshot.

## **Insert Anything into Report?**

Yes. Snapshot.

## **Class**

rptgen\_sl.Cdialog boxesnapshot

## **See Also**

State Loop

<b>Purpose</b>	Run child components only if current object type matches specified object type
<b>Description</b>	This component runs its children only if the current object type, as set by its parent Stateflow Hierarchy Loop, matches the selected object type.
<b>Properties</b>	<ul style="list-style-type: none"><li>• <b>Object type:</b> Specifies the Stateflow object type to include in the report.</li><li>• <b>Run only if Stateflow object has at least the following number of Stateflow children:</b> Specifies a minimum number of children that a Stateflow object must have to include in the report.</li><li>• <b>Automatically insert linking anchor:</b> Inserts a linking anchor before the reported object. If an anchor for this object exists, this option does not create a second anchor.</li></ul>
<b>Insert Anything into Report?</b>	No.
<b>Class</b>	rptgen_sf.csf_obj_filter
<b>See Also</b>	Stateflow Hierarchy Loop

# Stateflow Hierarchy

---

**Purpose** Provide visual representation of the hierarchy of a Stateflow object

**Description** This component inserts a tree that shows the hierarchy of a given Stateflow object.

## Tree Options

- **Construct tree from:** Specifies the object to use for the tree representation.
  - Current object
  - Root of current object: Starts reporting from the top of the hierarchy.
- **Emphasize current object in tree:** Highlights the current object in the tree representation.
- **Show number of parents:** Specifies the number of parents to include in the tree representation.
- **Show siblings:** Displays siblings in the tree representation.
- **Show children to depth:** Specifies the depth of children to display for each object in the tree representation.

## Children

- **Show junctions:** Specifies the level of junction detail to display in the generated report.
  - All
  - Non-redundant
  - None
- **Show transitions:** Specifies the level of transition detail to display in the generated report.
  - All
  - Labeled or non-redundant
  - Non-redundant
  - Labeled

## List Formatting

- None
- **Skip autogenerated charts under truth tables:** Excludes autogenerated charts under truth tables.
- **List style:**
  - Bulleted list
  - **Numbered list:** Allows you to specify numbering options in the **Numbering style** section.
    - **Numbering style:** Allows you to specify a numbering style. This setting supports only the RTF/DOC report format.
      - 1,2,3,4...
      - a,b,c,d...
      - A,B,C,D...
      - i,ii,iii,iv...
      - I,II,III,IV...

To show the parent number in each list entry, select **Show parent number in nested list (1.1.a)**. To show only the current number or letter, select **Show only current list value (a)**.

## Insert Anything into Report?

Yes. Tree graphic.

## Class

rptgen\_sf.csf\_hier

## See Also

Stateflow Hierarchy Loop

# Stateflow Hierarchy Loop

---

<b>Purpose</b>	Run child components on Stateflow object hierarchy
<b>Description</b>	This component runs its child components on the Stateflow object hierarchy.
<b>Loop Options</b>	<ul style="list-style-type: none"><li>• <b>Minimum legible font size:</b> Specifies the minimum font size to use in the report. The default font size, 8, is the smallest recommended font size.</li><li>• <b>Skip autogenerated charts under truth tables;</b> Excludes autogenerated charts under truth tables in the report.</li><li>• <b>Search Stateflow:</b> Reports on Stateflow charts with specified property name/property value pairs.</li></ul>
<b>Section Options</b>	<ul style="list-style-type: none"><li>• <b>Create section for each object in loop:</b> Inserts a section in the generated report for each object found in the loop.</li><li>• <b>Display the object type in the section title:</b> Inserts the object type automatically into the section title in the generated report.</li><li>• <b>Create link anchor for each object in loop:</b> Creates a hyperlink to the object in the generated report.</li></ul>
<b>Insert Anything into Report?</b>	No.
<b>Class</b>	rptgen_sf.csf_hier_loop
<b>See Also</b>	Stateflow Hierarchy

<b>Purpose</b>	Designate locations to which links point
<b>Description</b>	<p>This component designates a location to which other links point. The linking anchor is set to the current object, as defined by the parent component.</p> <p>This component must have the <code>Chart Loop</code>, <code>State Loop</code>, <code>Machine Loop</code>, or <code>Stateflow Filter</code> component as its parent.</p>
<b>Properties</b>	<b>Insert text:</b> Specifies text to appear after the linking anchor.
<b>Insert Anything into Report?</b>	Yes. A link, and possibly text, depending on attribute choices.
<b>Class</b>	<code>rptgen_sf.csf_obj_anchor</code>
<b>See Also</b>	<code>Chart Loop</code> , <code>Machine Loop</code> , <code>State Loop</code> , <code>Stateflow Filter</code> ,

# Stateflow Name

---

<b>Purpose</b>	Insert into report name of Stateflow object specified by parent component
<b>Description</b>	<p>This component inserts the name of the Stateflow object, as defined by its parent component, into the report. This component must have the State Loop, Chart Loop, or Stateflow Filter component as its parent.</p> <p>Using this component as the first child component of a Chapter/Subsection component allows the current Stateflow object name to be the chapter or section title.</p>
<b>Properties</b>	<ul style="list-style-type: none"><li>• <b>Display name as:</b> Displays the Stateflow object name in the report.<ul style="list-style-type: none"><li>▪ Name: For example, Object</li><li>▪ Type Name: For example, Object &lt;ObjectName&gt;</li><li>▪ Type - Name: For example, Object - &lt;ObjectName&gt;</li><li>▪ Type: Name: For example, Object: &lt;ObjectName&gt;</li></ul></li><li>• <b>Display name as:</b> Specifies the level of detail with which the Stateflow object name displays the report.<ul style="list-style-type: none"><li>▪ Object name</li><li>▪ Object name with Stateflow path</li><li>▪ Object name with Simulink and Stateflow path</li></ul></li></ul>
<b>Insert Anything into Report?</b>	Yes. Text.
<b>Class</b>	rptgen_sf.csf_obj_name
<b>See Also</b>	Chapter/Subsection, Chart Loop, State Loop, Stateflow Filter



<b>Purpose</b>	Insert into report table, text, or paragraph with information on selected Stateflow object property
<b>Description</b>	This component inserts a table, text, or paragraph that contains details of the selected Stateflow object property.
<b>Property to Display</b>	<b>Property name:</b> Specifies the Stateflow property name to display.
<b>Display Options</b>	<ul style="list-style-type: none"><li>• <b>Title:</b> Specifies a title to display in the generated report.<ul style="list-style-type: none"><li>▪ <b>Automatic:</b> Uses the parameter name as the title.</li><li>▪ <b>Custom:</b> Specifies a custom title.</li><li>▪ <b>None:</b> Specifies no title.</li></ul></li><li>• <b>Size limit:</b> Specifies the width of the display in the generated report. Units are in pixels. The size limit for a given table is the hypotenuse of the width and height of the table, <math>\sqrt{w^2+h^2}</math>. The size limit for text is the number of characters squared. If you exceed the size limit, the variable appears in condensed form.<p>Setting a size limit of 0 always displays the variable in long form, regardless of its size.</p></li><li>• <b>Display as:</b> Specifies a display style from the menu.<ul style="list-style-type: none"><li>▪ <b>Auto table/paragraph (default):</b> Displays as a table or paragraph based on the information.</li><li>▪ <b>Table:</b> Displays as a table.</li><li>▪ <b>Paragraph:</b> Displays as a text paragraph.</li><li>▪ <b>InLine text:</b> Displays in line with the surrounding text.</li></ul></li><li>• <b>Ignore if value is empty:</b> Excludes empty parameters from the generated report.</li></ul>

# Stateflow Property

---

## **Insert Anything into Report?**

Yes. Text, paragraph, or table.

## **Class**

rptgen\_sf.csf\_property

## **See Also**

Paragraph, Table, Text, Stateflow Name

**Purpose**

Insert into report property-value table for Stateflow object

**Description**

This component inserts a property-value table for a Stateflow object into the report. Use the **Stateflow Filter** component as the parent of this component.

For more information on working with Property Table components, see “Property Table Components” on page 6-6.

**Table**

Select a preset table, which is already formatted and set up, in the preset table list in the upper-left corner of the attributes page.

- **preset table:** Specifies a type of table to display the object property table.
  - Default
  - Machine
  - Chart
  - State
  - Truth table
  - EM function
  - Data
  - Event
  - Junction

To apply a preset table, select the table and click **Apply**.

- **Split property/value cells:** Splits property name/property value pairs into separate cells.
  - For the property name and property value to appear in adjacent horizontal cells, select the **Split property/value cells** check box. In this case, the table is in split mode, there is only one property name/property value pair per cell. If there is more than

# Stateflow Property Table

---

one name/property pair in a cell, only the first pair appears in the report. The report ignores all subsequent pairs.

- For the property name and property value to appear together in one cell, clear the **Split property/value cells** check box. This setting is nonsplit mode. Nonsplit mode supports more than one property name/property value pair and text.
- Before switching from nonsplit mode to split mode, make sure that there is only one property name/property value pair per table cell. When there is more than one property name/property value pair or any text in a given cell, only the first property name/property value pair appears in the report. The report omits subsequent pairs and text.
- **Display outer border:** Displays the outer border of the table in the generated report.
- **Table Cells:** Specifies table properties to modify. The selection in this pane affects the available fields in the **Cell Properties** pane.

## Cell Properties

The options in the **Title Properties** pane depend on the object selected in the **Table Cells** pane. If you select %<Name>, only **Contents** and **Show** appear. If you select any other object in the **Table Cells** pane, **Lower border** and **Right border** appear.

- **Contents:** Modifies the contents of the table cell selected in the **Table Cells** pane.
- **Alignment:** Justifies the contents of the selected table cell in the **Table Cells** pane.
  - Left
  - Center
  - Right
  - Double justified
- **Show As:** Specifies the format for the contents of the table cell.

- Value
- Property Value
- PROPERTY Value
- Property: Value
- PROPERTY: Value
- Property - Value
- PROPERTY - Value
- **Lower border:** Displays the lower border of the table in the generated report.
- **Right border:** Displays the right border of the table in the generated report.

## Creating Custom Tables

You can edit a preset table, such as the Blank 4x4 table, to create a custom table. Add and delete rows and add properties. To open the Edit Table dialog box, click **Edit**.

For details about creating custom property tables, see “Property Table Components” on page 6-6.

## Insert Anything into Report?

Yes. Table.

## Class

rptgen\_sf.csf\_prop\_table

## See Also

Stateflow Filter

# Stateflow Snapshot

---

**Purpose** Insert into report snapshot of Stateflow object

**Description** This component inserts a snapshot of a Stateflow object, defined by the Stateflow Filter parent component, into the report.

This component only executes if the selected object in the Stateflow Filter component is a graphical object, such as Chart, State, Transition, and Frame.

- Snapshot**
- **Image file format:** Specifies the image file format (for example, JPEG or TIFF). Select Automatic SF Format (default) to choose the format best suited for the specified report output format automatically. Otherwise, choose an image format that your output viewer can read.
    - Automatic SF Format (uses the file format selected in the Preferences dialog box)
    - Bitmap (16m-color)
    - Bitmap (256-color)
    - Black and white encapsulated PostScript
    - Black and white encapsulated PostScript (TIFF)
    - Black and white encapsulated PostScript2
    - Black and white encapsulated PostScript2 (TIFF)
    - Black and white PostScript
    - Black and white PostScript2
    - Color encapsulated PostScript
    - Color encapsulated PostScript (TIFF)
    - Color encapsulated PostScript2
    - Color encapsulated PostScript2 (TIFF)
    - Color PostScript
    - Color PostScript2

- JPEG high quality image
- JPEG medium quality image
- JPEG low quality image
- PNG 24-bit image
- Scalable vector graphics (SVG)
- TIFF - compressed
- TIFF - uncompressed
- Windows metafile
- **Paper orientation:**
  - Portrait
  - Landscape
  - Rotated
  - Largest dimension vertical: Positions the image so that its largest dimension is vertical.
  - Use Chart PaperOrientation setting: Uses the paper orientation setting for the chart. Use the Simulink PaperOrientation parameter to specify the orientation.
  - Full page image (PDF only): In PDF reports, scales images to fit the full page, minimizes page margins, and maximizes the size of the image by using either a portrait or landscape orientation. For more information about paper orientation, see the orient command in the MATLAB documentation.
- **Image sizing:**
  - Shrink image to minimum font size specified in Stateflow Hierarchy Loop: Resizes the image so that the text label font size is the minimum font size.
  - Fixed and Zoom: Specifies the size of the image.

# Stateflow Snapshot

---

- **Scaling:** Specifies the percentage of the image size to which to scale it.
- **Maximum size:** Specifies the maximum size for the snapshot in the generated report in the selected units. Use [width, height] format. In the units text box, select Inches, Centimeters, Points, or Normalized.
- **Use printframe:** Inserts a frame around your image. Use the default frame or create a custom one.
- **Use printframe paper settings:** Uses the dimensions and parameters as set by the specified **printframe** to size your image. If you choose this option, all other options (except for **Image file format**) become inactive.

## Properties

- **Include callouts to describe visible objects:** Displays descriptive callouts for visible objects.
- **Insert anchors for transitions and junctions:** Inserts anchors for transitions and junctions into the report.
  - None
  - Redundant children only
  - All
- **Run only if Stateflow object has at least the following number of children:** Specifies the minimum number of children that the current Stateflow object must have to include in the report. This option is inactive unless the selected object in the parent Stateflow Filter component is a graphical object.

---

**Tip** This option allows you to exclude certain images to decrease the size of the report for large models.

---



## Display Options

- **Scaling:**
  - **Use image size:** Uses the image size that you specify in the snapshot option.
  - **Zoom and Fixed size:** Allows you to specify the size of the image.
- **Size:** Specifies a size in inches for your image. The default is 7-by-9.
- **Max size:** Specifies the maximum size of the snapshot in the format `w h` (width, height). This field is active only if you choose **Zoom** from the **Scaling** selection list.
- **Units:** Specifies the units for the size of the snapshot. This field is active only if you choose **Zoom** or **Fixed size** in the **Image size** list box.
- **Alignment:** Only reports in PDF or RTF format support this property.
  - Auto
  - Right
  - Center
  - Left
- **Image title:**
  - **None(Default).**
  - **Object name:** Uses the object name as the title.
  - **Full Stateflow name:** Specifies the Stateflow path and the name of the object.
  - **Full Simulink + Stateflow name:** Specifies the Simulink path and name of the object.
  - **Custom:** Enter a different title.
- **Caption:** Specifies a caption for your image.
  - **None(Default).**
  - **Custom:** Specifies a custom caption.

# Stateflow Snapshot

---

- Description: Sets the caption to the value of the object Description property.

## **Insert Anything into Report?**

Yes. Image.

## **Class**

rptgen\_sf.csf\_obj\_snap

## **Class**

rptgen\_sf.csf\_prop\_table

## **See Also**

Stateflow Filter

<b>Purpose</b>	Table of properties or parameters of specified Stateflow object
<b>Description</b>	<p>This component displays a table of properties or parameters of specified Stateflow objects. It can have the following parents:</p> <ul style="list-style-type: none"><li>• Any Stateflow looping component</li><li>• Any Simulink looping component (Model Loop, System Loop, Block Loop, or Signal Loop)</li></ul>
<b>Properties</b>	<ul style="list-style-type: none"><li>• <b>Object type:</b> Specifies the object type to display in the generated report. This value affects the options available in the <b>Property Columns</b> pane.</li><li>• <b>Table title:</b> Specifies a title for the Summary Table in the generated report.<ul style="list-style-type: none"><li>▪ Automatic: Generates a title automatically from the parameter.</li><li>▪ Custom: Specifies a custom title.</li></ul></li></ul>
<b>Property Columns</b>	<ul style="list-style-type: none"><li>• <b>Property columns:</b> Displays the object properties to include in the Summary Table in the generated report.<ul style="list-style-type: none"><li>▪ To add a property:<ul style="list-style-type: none"><li>• Select the appropriate property level in the text box.</li><li>• In the context list under the text box, select the property that you want to add and click <b>Add</b>.</li></ul></li><li>▪ To delete a property, select the property name and press the <b>Delete</b> key.</li></ul></li></ul> <p>Some entries in the list of available properties (such as Depth) are “virtual” properties that you cannot access using the <code>get_param</code> command. The properties used for property/value filtering in the block and System Loop components must be retrievable by the <code>get_param</code>. Therefore, you cannot configure your Summary Table to report on all blocks of <code>Depth == 2</code>.</p>

# Stateflow Summary Table

---

- **Remove empty columns:** Removes empty columns from the Summary Table in the generated report.
- **Transpose table:** Changes the summary table rows into columns in the generated report, putting the property names in the first column and the values in the other columns.

## Object Rows

**Insert anchor for each row:** Inserts an anchor for each row in the summary table.

## Report On

- **Automatic list from context:** Reports on all blocks in the current context, as set by the parent component.
- **Custom - use block list:** Reports on a specified list of blocks. Specify the full path of each block.

## Loop Options

Choose block sorting options and reporting options in this pane.

- **Sort blocks:** Specifies how to sort blocks (applied to each level in a model):
  - **Alphabetically by block name:** Sorts blocks alphabetically by name.
  - **Alphabetically by system name:** Sorts systems alphabetically by name. Lists blocks in each system, but in no particular order.
  - **Alphabetically by full Simulink path:** Sorts blocks alphabetically by Simulink path.
  - **By block type:** Sorts blocks alphabetically by block type.
  - **By block depth:** Sorts blocks by their depth in the model.
  - **By layout (left to right):** Sorts blocks by their location in the model layout, by *rows*. The block appearing the furthest toward the left top corner of the model is the anchor for the row. The row contains all other blocks that overlap the horizontal area defined by the top and bottom edges of the anchor block. The other rows

# Stateflow Summary Table

use the same algorithm, using as the anchor the next unreported block nearest the left top of the model.

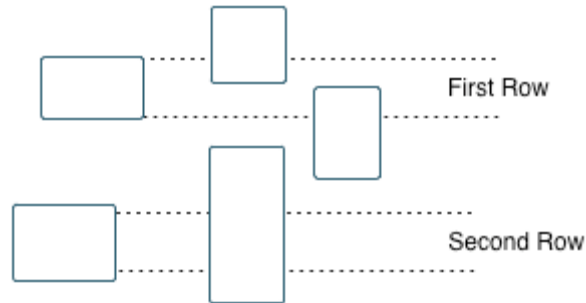

- By layout (top to bottom): Sorts blocks by their location in the model layout, by *columns*. The block appearing the furthest toward the left top corner of the model is the anchor for the column. The column contains all other blocks that overlap the vertical area defined by the left and right edges of the anchor block. The other columns use the same algorithm, using as the anchor the next unreported block nearest the left top of the model.
- By traversal order: Sorts blocks by traversal order.
- By simulation order: Sorts blocks by execution order.
- **Search for Simulink property name/property value pairs:** Reports on blocks with specified property name/property value pairs.
- **Search Stateflow:** Reports on Stateflow charts with specified property name/property value pairs.

## Insert Anything into Report?

Yes. Table.

## Class

rptgen\_sf.csf\_summ\_table

# Stateflow Summary Table

---

## **See Also**

Block Loop, Chart Loop, Model Loop, Object Loop, Signal Loop,  
State Loop, Stateflow Hierarchy Loop, System Loop

<b>Purpose</b>	Run child components if current system meets specified conditions
<b>Description</b>	This component runs its child components if the current system meets the conditions that you specify with this component.
<b>Properties</b>	<ul style="list-style-type: none"><li>• <b>Report only if system has at least N blocks:</b> Specifies the minimum number of blocks that the system must include for any of the child components to run. If you enter 0, child components run regardless of the number of blocks in the system.</li><li>• <b>Report only if system has at least N subsystems:</b> Specifies the minimum number of subsystems that the system must include for the child components to run. If you enter 0, child components run regardless of the number of subsystems in the system.</li><li>• <b>Report only if system mask type is:</b> Specifies which masks to include in the generated report.<ul style="list-style-type: none"><li>▪ Either masked or unmasked</li><li>▪ Masked</li><li>▪ Unmasked</li></ul></li><li>• <b>Custom filtering MATLAB code:</b> Specifies custom MATLAB filtering code that the System Filter applies when determining which systems and subsystems to report on in a System Loop component. The edit box includes a sample function (commented out) that you can use as a starting point for your own filtering function. Use the <code>isFiltered</code> variable for the output of your function. For example, to filter out systems and subsystems whose names start with <code>engine</code>, enter:<pre>isFiltered = strncmpi( currentSystem, 'engine', 6);</pre></li></ul>
<b>Insert Anything into Report?</b>	No.

# System Filter

---

**Class**            `rptgen_sf.csf_obj_filter`

**See Also**        System Loop



<b>Purpose</b>	Create nested list that shows hierarchy of specified system
<b>Description</b>	This component creates a nested list that shows the hierarchy of a specified system. The list can display all systems in a model, or the parents and children of the current system.
<b>Starting System</b>	<ul style="list-style-type: none"><li>• <b>Build list from:</b> Specifies the system or model from which to build the list.<ul style="list-style-type: none"><li>▪ Current system</li><li>▪ Current model</li></ul></li><li>• <b>Emphasize current system:</b> Highlights the current system or model in the generated report.</li></ul>
<b>Display Systems</b>	<ul style="list-style-type: none"><li>• <b>Show number of parents:</b> Specifies the number of parents to list.</li><li>• <b>Display peers of current system:</b> Shows the peers of the current system in the generated report.</li><li>• <b>Show children to depth:</b> Specifies the depth of children to list.</li></ul>
<b>List Formatting</b>	<ul style="list-style-type: none"><li>• <b>List style:</b><ul style="list-style-type: none"><li>▪ Bulleted list</li><li>▪ Numbered list: Allows you to select numbering options in the <b>Numbering style</b> section.</li></ul></li><li>• <b>Numbering style:</b> Allows you to select a numbering style in the selection list, by setting <b>List style</b> to <b>Numbered List</b>. Only the RTF/DOC report format supports this option.<ul style="list-style-type: none"><li>▪ 1,2,3,4,...</li><li>▪ a,b,c,d,...</li><li>▪ A,B,C,D,...</li><li>▪ i,ii,iii,iv,...</li><li>▪ I,II,III,IV,...</li></ul></li></ul>

# System Hierarchy

---

**Insert  
Anything  
into  
Report?**

Yes. List.

**Class**

rptgen\_sl.csl\_sys\_list

**See Also**

Model Loop, System Loop

- Purpose** Specify systems and subsystems on which to loop, as defined by parent component
- Description** This component runs its child components for each system defined by the parent component. For example, to include systems and subsystems within a given model in the report, you can include this component as the child of a Model Loop component.
- Report On**
- **Loop on Systems:**
    - **Select systems automatically:** Reports on all systems in the current context as set by the parent component.
      - Model Loop: Reports on systems in the current model.
      - System Loop: Reports on the current system.
      - Signal Loop: Reports on the parent system of the current signal.
      - Block Loop: Reports on the parent system of the current block. If this component does not have any of these components as its parent, selecting this option reports on all systems in all models.
    - **Custom - use system list:** Reports on a list of specified systems. Specify the full path of each system.
    - **%<VariableName>:** Inserts the value of a variable from the MATLAB workspace. The %<> notation can denote a string or cell array. For more information, see %<VariableName> Notation on the Text component reference page.
    - **Include subsystems in Simulink functions:** Specifies whether to include subsystems in Simulink functions. By default, this option is enabled.
  - **Sort Systems:** Specifies how to sort systems.
    - **Alphabetically by system name (default):** Sorts systems alphabetically by name.
- Loop Options**

# System Loop

---

- **By number of blocks in system:** Sorts systems by number of blocks. The list shows systems by decreasing number of blocks; that is, the system with the largest number of blocks appears first in the list.
- **By system depth:** Sorts systems by their depth in the model.
- **By traversal order:** Sorts systems in traversal order.
- **Search for:** Reports only on blocks with the specified property name/property value pairs. To enable searching, click the check box. In the first row of the property name and property value table, click inside the edit box, delete the existing text, and type the property

name and value. To add a row, use the **Add row** button ()

For information about subsystem property names and values, in “Block-Specific Parameters”, see the “Ports & Subsystems Library Block Parameters” section.

## Section Options

- **Create section for each object in loop:** Inserts a section in the generated report for each object found in the loop.
- **Display the object type in the section title:** Inserts the object type automatically into the section title in the generated report.
- **Number sections by system hierarchy:** Hierarchically numbers sections in the generated report. Requires that **Sort Systems** be set to **By traversal order**.
- **Create link anchor for each object in loop:** Creates a hyperlink to the object in the generated report.

## Examples

For an example of how to use this component with a `Model Loop` as its parent, see `Model Loop`.

**Insert  
Anything  
into  
Report?**

Yes, inserts a section if you select the **Create section for each object in loop** option.

**Class**

rptgen\_sl.csl\_sys\_loop

**See Also**

Block Loop, Model Loop, Signal Loop, System Loop

# System Snapshot

---

**Purpose** Insert snapshot of the current system into report

**Description** This component inserts a snapshot of the current system into the report. The Snapshot options control how the image file is stored. The Properties options control whether the image display includes callouts and a print frame. The Display options control how the image is displayed in a browser.

## Snapshot Options

- **Format:** Specifies the image file format (for example, JPEG or TIFF). Select `Automatic SL Format` (the default) to choose the format best suited for the specified report output format automatically. Otherwise, choose an image format that your output viewer can read.
  - `Automatic SL Format` (uses file format selected in the Preferences dialog box)
  - `Bitmap (16m-color)`
  - `Bitmap (256-color)`
  - `Black and white encapsulated PostScript`
  - `Black and white encapsulated PostScript (TIFF)`
  - `Black and white encapsulated PostScript2`
  - `Black and white encapsulated PostScript2 (TIFF)`
  - `Black and white PostScript`
  - `Black and white PostScript2`
  - `Color encapsulated PostScript`
  - `Color encapsulated PostScript (TIFF)`
  - `Color encapsulated PostScript2`
  - `Color encapsulated PostScript2 (TIFF)`
  - `Color PostScript`
  - `Color PostScript2`
  - `JPEG high quality image`

- JPEG low quality image
- JPEG medium quality image
- PNG (screenshot)
- PNG 24-bit image
- Scalable Vector Graphics
- Windows metafile
- **Orientation:**
  - Largest dimension vertical: Positions the image so that its largest dimension is vertical.
  - Landscape
  - Portrait
  - Use system orientation: Uses the paper orientation setting for the system. Use the Simulink PaperOrientation parameter to specify the orientation.
  - Full page image (PDF only): In PDF reports, scales images to fit the full page, minimizes page margins, and maximizes the size of the image by using either a portrait or landscape orientation.
- **Scaling:** Controls the size of the image in the image file.
  - Automatic (default): Automatically scales the image to output dimensions.
  - Custom: Specifies image size.
  - Zoom: Enlarges or reduces the image size to the percent that you specify. Use **Max Size** to specify the maximum size other than the default for the image.

# System Snapshot

---

---

**Note** Selecting the **Use printframe** deactivates the Custom and Zoom options and automatically scales the image to the print frame size.

---

## Properties Options

- **Include callouts to describe visible objects:** Displays descriptive callouts for visible objects
- **Use printframe:** Prints a frame around the image. You can use the default frame, `rptdefaultframe.fig`, or use the Frame Editor to build a custom frame. For more information, see the `frameedit` function in Simulink documentation.

The default frame is five inches wide and four inches high. It includes the name of the system and the model folder. This frame is optimized for use with a portrait paper orientation. The Flight Control Model in the f14 Simulink model appears here with the default Simulink Report Generator frame option.



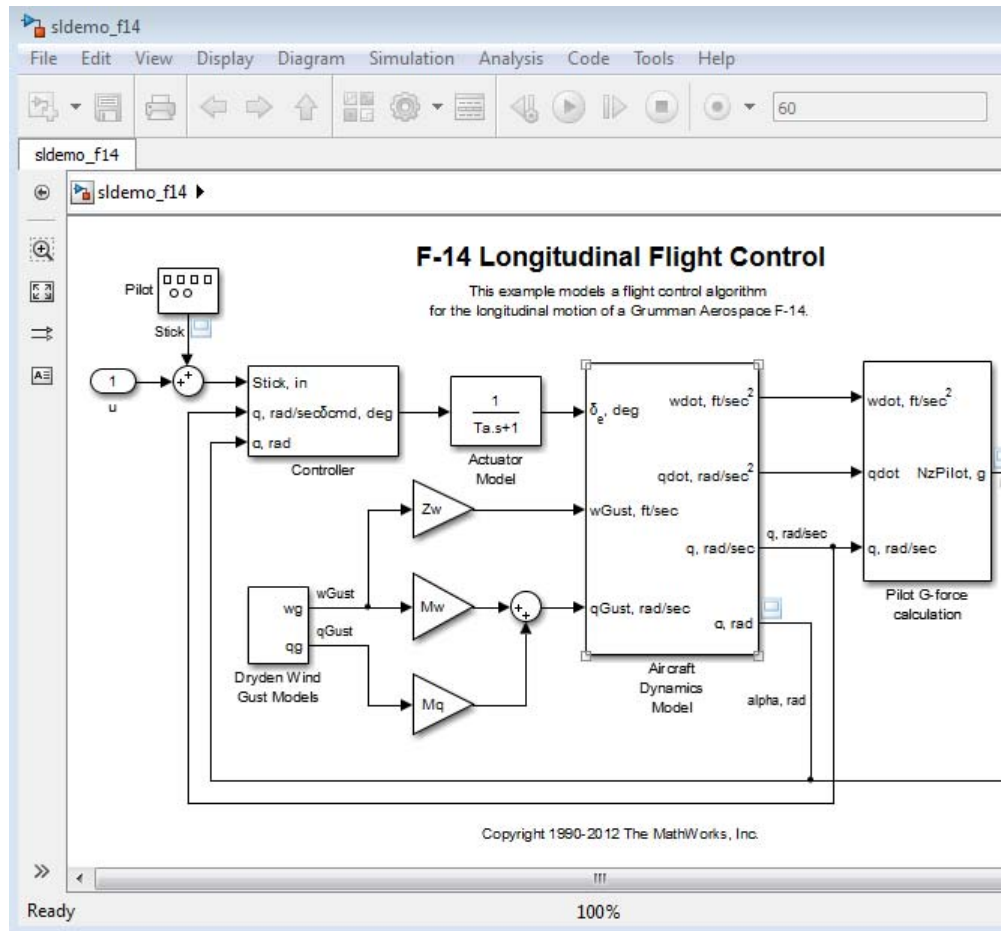

## Display Options

To access the display options, click the **Advanced** button.

- **Scaling:** Controls size of the image, as displayed in a browser. Making an image larger using this option does not affect the storage size of the image, but the quality of the displayed image decreases as you increase the size of the displayed image.

# System Snapshot

---

- **Fixed size:** Specifies the number and type of units.
- **Zoom:** Specifies the percentage, maximum size, and units of measure.
- **Use image size:** Causes the image to appear the same size in the report as on screen.
- **Size:** Specifies the size of the snapshot in a browser, using the format `w h` (width, height). This field is active only if you choose **Fixed size** in the **Scaling** selection list.
- **Max size:** Specifies the maximum size of the snapshot in a browser, using the format `w h` (width, height). This field is active only if you choose **Zoom** in the **Scaling** selection list.
- **Units:** Specifies the units for the size of the snapshot in a browser. This field is active only if you choose **Fixed size** in the **Image size** list box.
- **Alignment:** Only reports in PDF or RTF format support this property.
  - Auto
  - Right
  - Left
  - Center
- **Image title:**
  - None (Default)
  - **System name:** Uses the system name as the image name.
  - **Full system name:** Uses the system name, with path information, as the image name.
  - **Custom:** Specifies a custom title.
- **Caption:**
  - None (Default)
  - **Description (use system description)**

- Custom: Specifies a custom caption.

**Insert  
Anything  
into  
Report?**

Yes. Image.

**Class**

rptgen\_sl.cs1\_sys\_snap

**See Also**

System Loop

# To Workspace Plot

---

## **Purpose**

Capture plot figure created in the MATLAB workspace

## **Description**

This component captures a plot figure created in the MATLAB workspace, and then inserts one or both of the following into the report:

- A table that includes input and output numeric values.
- A figure that plots the values included in the table.

## **Print Options**

- **Image file format:** Specifies the image file format (for example, JPEG or TIFF) from this list. Select `Automatic HG Format` (the default) to choose the format best suited for the specified report output format automatically. Otherwise, choose an image format that your output viewer can read. Other options are:
  - `Automatic HG Format` (Uses the file format selected in the Preferences dialog box)
  - `Bitmap (16m-color)`
  - `Bitmap (256-color)`
  - `Black and white encapsulated PostScript`
  - `Black and white encapsulated PostScript (TIFF)`
  - `Black and white encapsulated PostScript2`
  - `Black and white encapsulated PostScript2 (TIFF)`
  - `Black and white PostScript`
  - `Black and white PostScript2`
  - `Color encapsulated PostScript`
  - `Color encapsulated PostScript (TIFF)`
  - `Color encapsulated PostScript2`
  - `Color encapsulated PostScript2 (TIFF)`
  - `Color PostScript`
  - `Color PostScript2`

- JPEG high quality image
- JPEG medium quality image
- JPEG low quality image
- PNG 24-bit image
- TIFF - compressed
- TIFF - uncompressed
- Windows metafile
- **Paper orientation:**
  - Landscape
  - Portrait
  - Rotated
  - Use figure orientation: Uses the orientation for the figure, which you set with the `orient` command.
  - Full page image (PDF only): In PDF reports, scales images to fit the full page, minimizes page margins, and maximizes the size of the image by using either a portrait or landscape orientation. For more information about paper orientation, see the `orient` command in the MATLAB documentation.
- **Image size:**
  - Use figure `PaperPositionMode` setting: Uses the `PaperPositionMode` property of the Handle Graphics figure to set the image size in the report. For more information about paper position mode, see the `orient` command in the MATLAB documentation.
  - Automatic (same size as on screen): Sets the image in the report to the same size as it appears on the screen.
  - Custom: Specifies a custom image size. Specify the image size in the `size` and `units` fields.

# To Workspace Plot

---

- **Size:** Specifies the size of the Handle Graphics figure snapshot in the format `wxh` (width times height). This field is active only if you choose **Custom** in the **Image size** list box.
- **Units:** Specifies units for the size of the Handle Graphics figure snapshot. This field is active only if you choose **Set image size** in the **Custom** list box.
- **Invert hardcopy:** Uses the Handle Graphics figures `InvertHardcopy` property, which inverts colors for printing; it changes dark colors to light colors, and light colors to dark colors.
  - **Automatic:** Automatically changes dark axes colors to light axes colors. If the axes color is a light color, it is unchanged.
  - **Invert:** Changes dark axes colors to light axes colors, and light axes colors to dark axes colors.
  - **Don't invert:** Retains image colors displayed on screen in the printed report.
  - **Use figure's InvertHardcopy setting:** Uses the `InvertHardcopy` property set in the Handle Graphics image.
  - **Make figure background transparent:** Makes the image background transparent.

## Display Options

- **Scaling**
  - **Fixed size:** Specifies the number and type of units.
  - **Zoom:** Specifies the percentage, maximum size, and units of measure.
  - **Use image size:** Causes the image to appear the same size in the report as on screen.
- **Size:** Specifies the size of the snapshot in the format `w h` (width, height). This field is active only if you choose **Fixed size** in the **Scaling** list.

- **Max size:** Specifies the maximum size of the snapshot in the format w h (width, height). This field is active only if you choose Zoom from the **Scaling** list.
- **Units:** Specifies units for the size of the snapshot. This field is active only if you choose Zoom or Fixed size in the **Image size** list box.
- **Alignment:** Only reports in PDF or RTF format support this property.
  - Auto
  - Right
  - Left
  - Center
- **Title:** Specifies text to appear above the snapshot.
- **Caption:** Specifies text to appear under the snapshot.

## Insert Anything into Report?

Yes. Figure.

## Class

rptgen\_sl.csl\_blk\_toworkspace

## See Also

Figure Loop

# Truth Table

---

<b>Purpose</b>	Report on truth tables in Simulink and Stateflow models
<b>Description</b>	<p>The Truth Table component reports on truth tables in Simulink and Stateflow models. It displays both the condition table and the action table. The parent component of the Truth Table determines its behavior.</p> <ul style="list-style-type: none"><li>• <b>Model Loop:</b> Reports on all truth tables in the current model.</li><li>• <b>System Loop:</b> Reports on all truth tables in the current system.</li><li>• <b>Block Loop :</b> Reports on all truth tables in the current block.</li><li>• <b>Signal Loop:</b> Reports on all truth tables in the current signal.</li></ul>
<b>Title</b>	<p><b>Title:</b> Specifies a title for the truth table.</p> <ul style="list-style-type: none"><li>• No title</li><li>• Use Stateflow name</li><li>• Custom</li></ul>
<b>Condition Table</b>	<p>Specify display parameters for the condition table.</p> <ul style="list-style-type: none"><li>• <b>Show header:</b> Displays the column headers in the table.</li><li>• <b>Show number:</b> Displays the condition number column in the table.</li><li>• <b>Show condition:</b> Displays the condition column in the table.</li><li>• <b>Show description:</b> Displays the description column in the table.</li><li>• <b>Wrap if column count:</b> Specifies how many columns to display before creating a table continuation. If the specified number is greater than the number of columns that can appear on the page, some columns do not appear in the report.</li></ul>
<b>Action Table</b>	<ul style="list-style-type: none"><li>• <b>Show header:</b> Displays the column headers in the table.</li><li>• <b>Show number:</b> Displays the condition number column in the table.</li><li>• <b>Show condition:</b> Displays the condition column in the table.</li></ul>



- **Show description:** Displays the description column in the table. If you do not select this option, no action table appears in the report.

## **Insert Anything into Report?**

Yes. Table.

## **Class**

rptgen\_sf.csf\_truthtable

## **See Also**

Block Loop, Model Loop, Signal Loop, System Loop

# Truth Table

---

# Function Reference

---

GUI (p. 10-2)

Report Generation (p. 10-3)

Web Views (p. 10-4)

Perform GUI-related tasks

Generate reports

Export Simulink models to Web Views

## **GUI**

`rptlist`

Return list of all reports in MATLAB path

## Report Generation

report

Generate report from specified  
Simulink system

## **Web Views**

slwebview

Export Simulink models to Web views

# Functions – Alphabetical List

---

report  
rptlist  
slwebview

# report

---

**Purpose** Generate report from specified Simulink system

**Syntax** `report (system_name)`

**Description** `report (system_name)` generates a report from the specified Simulink system. If the specified system's `ReportName` property is empty, the `ReportName` property of its parent system is used instead.

**See Also** `report`

**How To**

- “Report Generation”



**Purpose** Return list of all report s in MATLAB path

**Syntax** `rptlist ('system_name')`

**Description** `rptlist ('system_name')` opens the Report Explorer with the Simulink system's ReportName property selected.

**See Also** `report` | `setedit`

# slwebview

---

**Purpose** Export Simulink models to Web views

**Syntax**

```
slwebview
filename = slwebview(system_name)
... = slwebview(system_name, 'option1', value1, ...)
```

**Description** This function creates an interactive Web view of a Simulink model. For more information about Web views, see “Web Display of Model Information”.

- `slwebview` with no arguments starts the Web View dialog box in the Report Explorer.
- `filename = slwebview(system_name)` exports the subsystem `system_name` and its child systems to the file `filename`.

You can specify `system_name` as:

- A string
- A handle to a Simulink subsystem or block diagram
- A handle to a Stateflow chart or subchart
- `... = slwebview(system_name, 'option1', value1, ...)` sets Web view export options. For more information, see “Export Options” on page 11-4.

## Export Options

The first argument passed to the `slwebview` command is the name (a string) or a handle identifying the Simulink system or Stateflow chart to export. Remaining arguments are alternating name and value pairs (strings) that set export options.

## SearchScope

Specifies which Simulink systems or Stateflow charts to export.

<b>'SearchScope' Option Value</b>	<b>Meaning</b>
Current	Export only the Simulink system or the Stateflow chart specified by the first argument
CurrentAndAbove	Export the Simulink system or the Stateflow chart specified by the first argument and all systems or charts that contain it
CurrentAndBelow (Default)	Export the Simulink system or the Stateflow chart specified by the first argument and all systems or charts that it contains
All	Export all Simulink systems or Stateflow charts in the model that contains the system or chart specified by the first argument

### **LookUnderMasks**

This option is relevant only when you are exporting Simulink subsystems or Stateflow subcharts that the specified system or chart contains. It specifies which masked blocks, if any, in subsystems or subcharts to export.

<b>'LookUnderMasks' Option Value</b>	<b>Meaning</b>
None	Do not export any masked blocks
Graphical (Default)	Export only masked blocks that have no workspaces and no dialog boxes
Functional	Export only masked blocks that have no dialog boxes
All	Export all masked blocks

## FollowLinks

Specifies whether to follow links into library blocks.

'FollowLinks' Option Value	Meaning
On	Follow links into library blocks
Off (Default)	Do not follow links into library blocks

## FollowModelReference

Specifies whether to follow links into referenced models.

'FollowModelReference' Option Value	Meaning
On	Follow links into referenced models
Off (Default)	Do not follow links into referenced models

## ViewFile

Specifies whether to display the Web view in a Web browser.

'ViewFile' Option Value	Meaning
true (Default)	Display the Web view in a Web browser
false	Do not display the Web view in a Web browser

## How To

- “Web Display of Model Information”

# Examples

---

Use this list to find examples in the documentation.

## **Creating Reports**

Chapter 3, “Creating Simulink Reports”

“Compare Simulink Model XML Files” on page 7-2

## **Generating Reports from MATLAB Files**

Generate Reports from MATLAB® Files on page 4-20

## **Creating Web Views**

“Create Web Views of Simulink Models” on page 5-11



## **Working with Components**

“Property Table Components” on page 6-6

“Summary Table Components” on page 6-17

“Dynamic Reporting Components” on page 6-22

Generating Reports on Specified Systems and their Subsystems on page 9-60

Temporarily Omitting a Model from a Loop on page 9-65



## A

Annotation Loop component 9-4

## B

Block Execution Order List component 9-6

Block Loop component 9-7

Block Type Count component 9-11

Bus component 9-13

## C

Chart Loop component 9-15

Code Generation Summary component 9-18  
component

    Stateflow Name 9-144

components

    about 6-2

    Annotation Loop 9-4

    Block Execution Order List 9-6

    Block Loop 9-7

    Block Type Count 9-11

    Bus 9-13

    Chart Loop 9-15

    Code Generation Summary 9-18

    Documentation 9-20

    Fixed Point Logging Options 9-26

    Fixed Point Property Table 9-28

    Fixed Point Summary Table 9-31

    Import Generated Code 9-34

    Look-Up Table 9-35

    looping components

        about 6-22

    MATLAB Function 9-23 9-46

    Missing Requirements Block Loop 9-42

    Missing Requirements System Loop 9-50

    Model Advisor Report 9-53

    Model Change Log 9-54

    Model Configuration Set 9-56 to 9-57

    Model Simulation 9-71

    Object Loop 9-73

    Requirements Block Loop 9-75

    Requirements Documents Table 9-78

    Requirements Management Interface  
        components 8-3

    Requirements Signal Loop 9-80

    Requirements Summary Table 9-82

    Requirements System Loop 9-86

    Requirements Table 9-88

    Scope Snapshot 9-90

    Signal Loop 9-95

    Simulin Function System Loop 9-102

    Simulink Automatic Table 9-98

    Simulink Blocks components 8-7

    Simulink Coder 8-2

    Simulink components 8-4

    Simulink Dialog Snapshot 9-100

    Simulink Fixed Point components 8-8

    Simulink Functions and Variables 9-104

    Simulink Library Information 9-108

    Simulink Linking Anchor 9-112

    Simulink Name 9-114

    Simulink Property 9-116

    Simulink Property Table 9-118

    Simulink Sample Time 9-122

    Simulink Summary Table 9-123

    Simulink Workspace Variable 9-128

    Simulink Workspace Variable Loop 9-131

    State Loop 9-132

    Stateflow Automatic Table 9-134

    Stateflow components 8-9

    Stateflow Count 9-136

    Stateflow Dialog Snapshot 9-137

    Stateflow Filter 9-139

    Stateflow Hierarchy 9-140

    Stateflow Hierarchy Loop 9-142

    Stateflow Linking Anchor 9-143

    Stateflow Property 9-145

    Stateflow Property Table 9-147

    Stateflow Snapshot 9-150

- Stateflow Summary Table 9-155
- System Filter 9-159
- System Hierarchy 9-161
- System Loop 9-163
- System Snapshot 9-166
- To Workspace Plot 9-172
- Truth Table 9-176

components,

- Machine Loop 9-41

converting English strings to other languages 4-15

converting XML documents

- using Report Explorer 4-16
- using the command line 4-18

converting XML documents to different format 4-16

## D

- DocBook SGML report 4-4
- Documentation component 9-20

## F

- Fixed Point Logging Options component 9-26
- Fixed Point Property Table component 9-28
- Fixed Point Summary Table component 9-31
- flow object tree (XML) 4-4
- functions
  - report 11-2
  - rptlist 11-3
  - slwebview 11-4

## H

- Handle Graphics
  - figure property table 6-6
- HTML report
  - stylesheets 4-4

## I

- Import Generated Code component 9-34

## L

- legacy report setup files
  - working with 4-23
- localization 4-15
- log files
  - creating 4-19
- Look-Up Table component 9-35
- looping components
  - about 6-22

## M

- Machine Loop component 9-41
- MATLAB code
  - generating from report setup files 4-20
- MATLAB Function component 9-23 9-46
- Microsoft Word report 4-4
- Missing Requirements Block Loop component 9-42
- Missing Requirements System Loop component 9-50
- Model Advisor Report component 9-53
- Model Change Log component 9-54
- Model Configuration set component 9-56
- Model Configuration Set component 9-57
- Model Simulation component 9-71

## O

- Object Loop component 9-73

## P

- property tables
  - adding and deleting columns and rows 6-14
  - creating custom tables 6-16

- displaying or hiding table and cell borders 6-15
- editing table titles 6-12
- entering text into table cells 6-12
- modifying properties in a table 6-13
- property name/property value pairs 6-9

## R

- Report Explorer
  - About 1-15
- report formats 1-20
- report function 11-2
- reports
  - descriptions 4-14
  - generating 4-1
  - setting output options 4-4
- Requirements Block Loop component 9-75
- Requirements Documents Table component 9-78
- Requirements Management Interface
  - components 8-3
- Requirements Signal Loop component 9-80
- Requirements Summary Table component 9-82
- Requirements System Loop component 9-86
- Requirements Table component 9-88
- rich text format 4-4
- rptlist function 11-3

## S

- Scope Snapshot component 9-90
- SGML report 4-4
- Signal Loop component 9-95
- Simulink Automatic Table component 9-98
- Simulink Blocks components 8-7
- Simulink Coder components 8-2
- Simulink components 8-4
- Simulink Dialog Snapshot component 9-100
- Simulink Fixed Point components 8-8

- Simulink Function System Loop
  - component 9-102
- Simulink Functions and Variables
  - component 9-104
- Simulink Library Information component 9-108
- Simulink Linking Anchor component 9-112
- Simulink Name component 9-114
- Simulink Property component 9-116
- Simulink Property Table component 9-118
- Simulink Report Generator software
  - components
    - definition 3-5
  - creating reports 3-1
  - generating reports 4-1
  - interaction with MATLAB and Simulink 1-18
  - report formats 1-20
  - report setup files
    - adding components to 3-5
    - setting report options 3-3
  - tutorial 3-1
  - workflow 1-9
- Simulink Sample Time component 9-122
- Simulink Summary Table component 9-123
- Simulink Workspace Variable component 9-128
- Simulink Workspace Variable Loop
  - component 9-131
- slwebview function 11-4
- State Loop component 9-132
- Stateflow Automatic Table component 9-134
- Stateflow components 8-9
- Stateflow Count component 9-136
- Stateflow Dialog Snapshot component 9-137
- Stateflow Filter component 9-139
- Stateflow Hierarchy component 9-140
- Stateflow Hierarchy Loop component 9-142
- Stateflow Linking Anchor component 9-143
- Stateflow Name component 9-144
- Stateflow Property component 9-145
- Stateflow Property Table component 9-147

- Stateflow Snapshot component 9-150
- Stateflow Summary Table component 9-155
- stylesheets 4-4
  - HTML 4-8
  - PDF 4-7
  - RTF (DSSSL Print) and Word 4-9
  - Web 4-8
- Summary Table components
  - working with 6-17
- System Filter component 9-159
- System Hierarchy component 9-161
- System Loop component 9-163
- System Snapshot component 9-166

## **T**

- To Workspace Plot component 9-172
- troubleshooting 4-25
- Truth Table component 9-176

## **W**

- Web stylesheet 4-4
- Web views
  - browser requirements 1-21

- exporting Simulink models 5-3
  - setting export options 5-3
- generating 5-5
- navigating 5-7
- overview 5-2
- tutorial 5-11
- viewing 5-5

## **X**

- XML comparison
  - introduction 7-2
  - report 7-10
  - reverse annotation 7-14
  - selecting files 7-5
- XML documents
  - converting to different format 4-16
  - converting to different formats
    - using Report Explorer 4-16
    - using the command line 4-18
- XML report 4-4
- XML source files
  - editing 4-18